

4980170

Spectrum Analyzer Series
APPLICATION NOTE 150-3

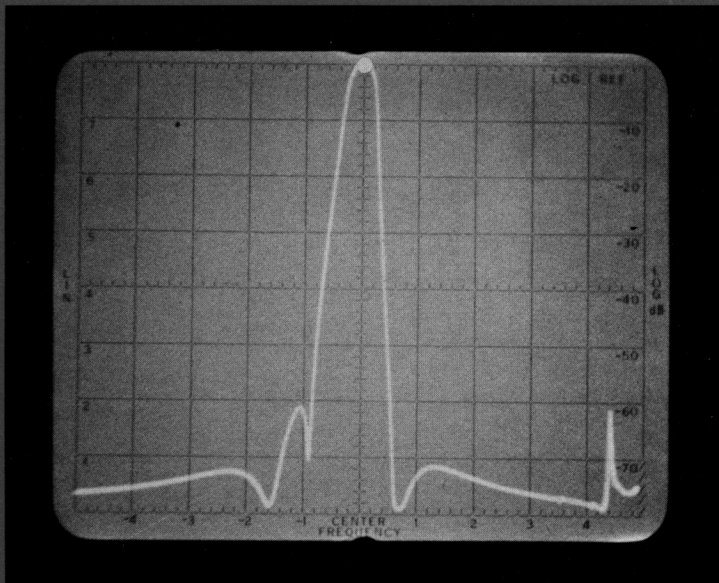

SPECTRUM ANALYSIS...
Swept Frequency Measurements
and Selective Frequency Counting
with a Tracking Generator

APPLICATION NOTE 150-3

SPECTRUM ANALYSIS...

**Swept Frequency Measurements
and Selective Frequency Counting
with a Tracking Generator**

Printed FEBRUARY 1974

HEWLETT  PACKARD

	Page
Introduction	1
Chapter 1. Versatile Measurements	2
Chapter 2. The Spectrum Analyzer/Tracking Generator	
I. The Spectrum Analyzer	4
II. The Tracking Generator	6
III. Open-Loop System	7
IV. Closed-Loop System	9
Chapter 3. The 8443A Tracking Generator	12
The 8443B Tracking Generator	18
Chapter 4. The 8444A Tracking Generator	20
Chapter 5. The 8556A Tuning Section/Tracking Generator	25
Chapter 6. Special Applications	
Overall Receiver Response	32
Loop-Gain	33
Beat Frequency Technique (Improved 8444A Frequency Accuracy)	35
Probing Techniques with the Spectrum Analyzer/Tracking Generator	37
Automatic Spectrum Surveillance	38
Tracking Generator to 18 GHz	40
Appendix A. Theory of Operation and Block Diagrams	
8443A	43
8443B	44
8444A	45
8556A	48
Appendix B. Transmission/Reflection Formulas	50

INTRODUCTION

The objective of this Application Note is to familiarize the reader with the Hewlett-Packard tracking generators and describe their measurement capabilities and applications.

The tracking generator is a companion instrument to the spectrum analyzer. However, the spectrum analyzer is not discussed here in any length since several application notes are available on the subject. These notes are:

The Spectrum Analyzer for Design Engineers (No. 5952-0932)

AN-134, Audio Frequency Measurements with the
8556A-8552B Spectrum Analyzer

AN-136, Understanding and Operating the 8555A Spectrum
Analyzer and 8445B Preselector

AN-150, Spectrum Analysis . . . Spectrum Analyzer Basics

AN-150-1, Spectrum Analysis . . . Amplitude and Frequency
Modulation

AN-150-2, Spectrum Analysis . . . Pulsed RF

AN-150B, Spectrum Analysis . . . Using the
8557A and 8558B Spectrum Analyzers

CHAPTER 1
VERSATILE MEASUREMENTS*
THE SPECTRUM ANALYZER/TRACKING GENERATOR

THE SPECTRUM ANALYZER/TRACKING GENERATOR MEASURES MOST SIGNAL PARAMETERS, EXCEPT PHASE AND DC VOLTAGE. THE TRACKING GENERATOR IS BASICALLY USED IN TWO WAYS: OPEN-LOOP FOR PRE-CISE MEASUREMENT OF FREQUENCY AND CLOSED-LOOP FOR SWEPT FREQUENCY MEASUREMENTS.

PRECISE MEASUREMENT OF FREQUENCY (OPEN-LOOP)

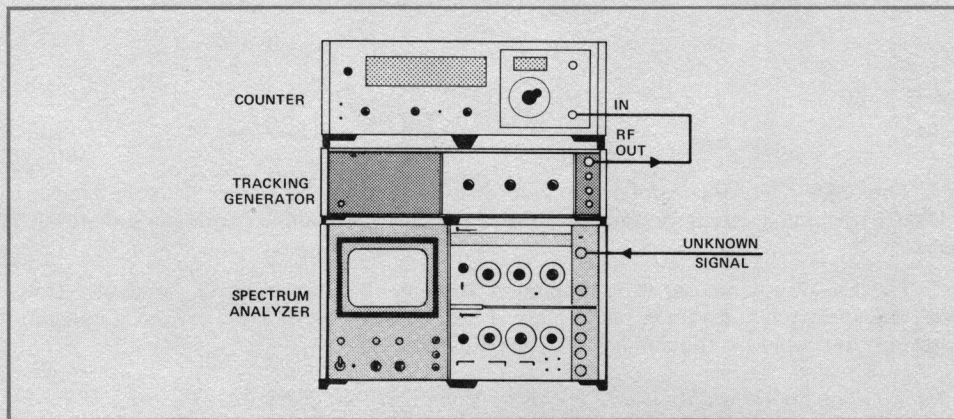

Figure 1. Precise Measurement of Frequency (Open Loop).

SELECTIVE, SENSITIVE FREQUENCY COUNTING
along with basic spectrum analyzer applications such as:

- Absolute Power Levels
- Distortion
- Amplitude Modulation
- Frequency Modulation
- Pulsed RF Modulation
- Frequency Drift
- Frequency Pulling

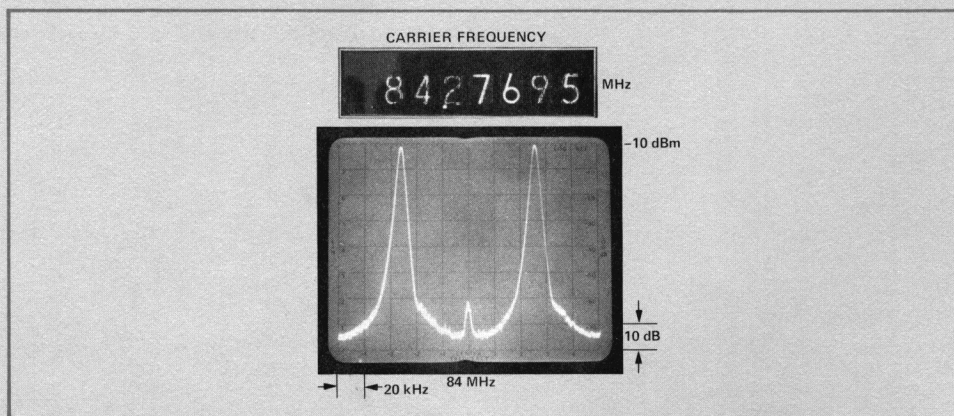

Figure 2. Suppressed Carrier Spectrum 84.27695 MHz.

* Refer to Chapter 6 for more specialized applications.

SWEPT FREQUENCY MEASUREMENTS (CLOSED-LOOP)

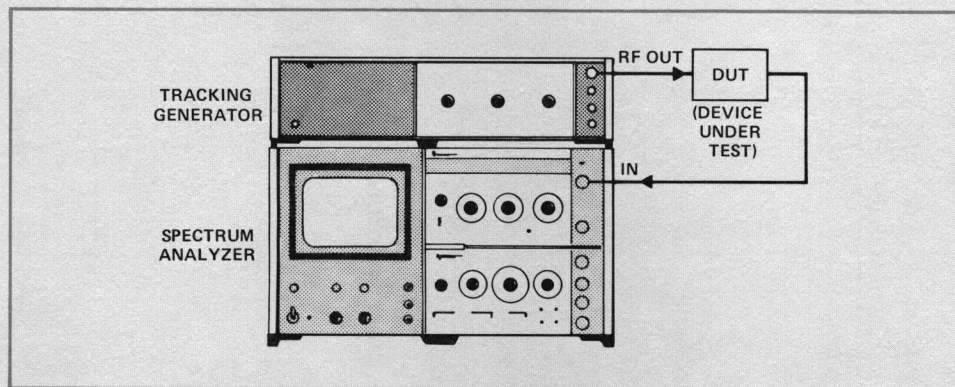

Figure 3. Swept Frequency Measurements (Closed-Loop).

DEVICE CHARACTERIZATION

1. Swept Transmission Characteristics
Insertion Loss
Gain
2. Swept Reflection Characteristics
Reflection Coefficient
Return Loss
SWR

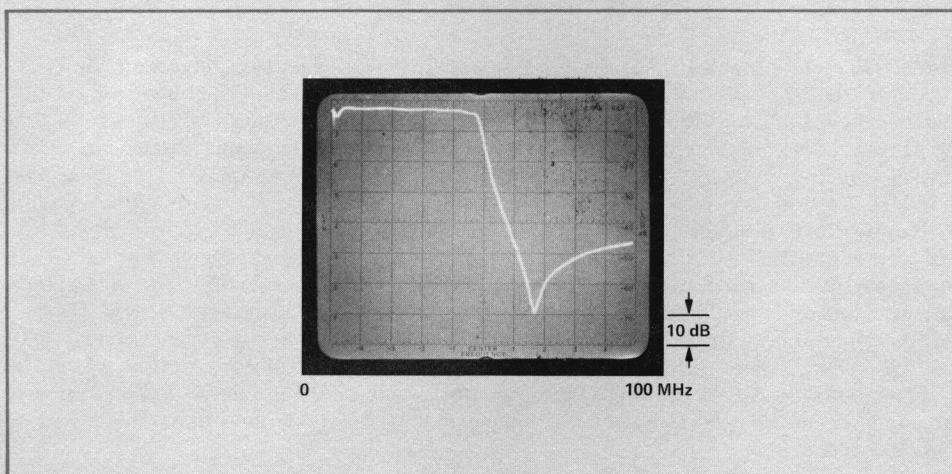

Figure 4. Low Pass Filter Response.

CHAPTER 2

I. THE SPECTRUM ANALYZER

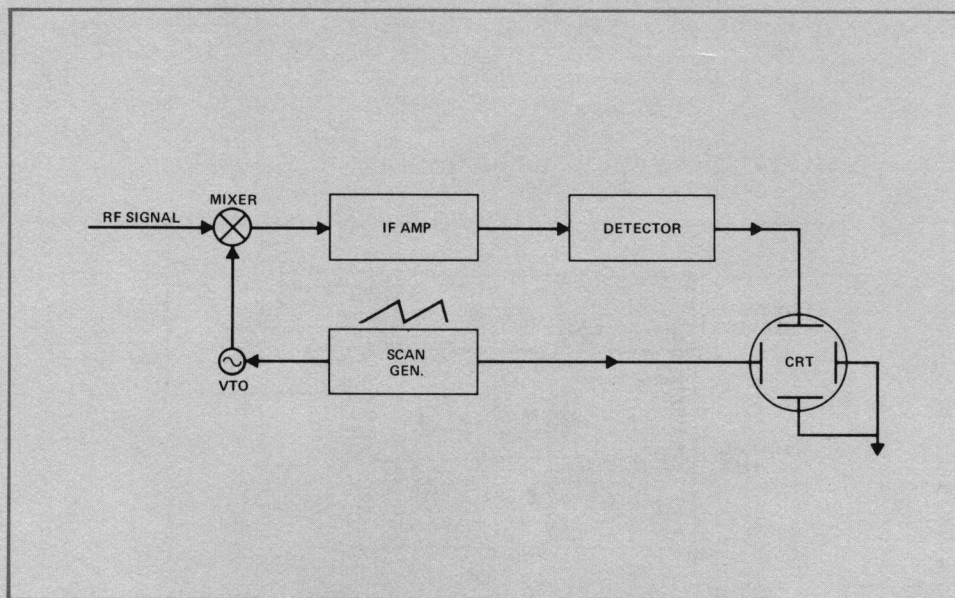

Figure 5. Simplified Spectrum Analyzer Block Diagram.

A simplified diagram is shown for a typical spectrum analyzer. A superheterodyne receiver, the spectrum analyzer is electronically tunable by applying an adjustable saw-tooth voltage ramp to a voltage-tuned local oscillator (VTO). The same saw-tooth voltage ramp is applied simultaneously to the horizontal deflection plates of the CRT to form the frequency axis of the display. The input signal is mixed with a signal from the VTO, the output of the mixer is amplified, detected, and then applied to the vertical plates of the CRT. Thus, the vertical deflection is proportional to the amplitude of the input signal.

For an input signal, F_s , the VTO frequency is tuned so that

$$F_{VTO} - F_s = F_{IF}$$

When this equation is satisfied, the input signal is detected and displayed on the CRT. Furthermore, by slowly sweeping the full saw-tooth voltage, the VTO sweeps through its frequency range and the output of the mixer will be a wide range of frequencies, but the IF amplifier will pass only those frequencies within its passband. Hence, the CRT display (spectrum) for a CW signal is simply a plot of the passband of the IF amplifier. In the real world, however, we can readily identify several applications where a wide IF bandwidth is desirable, while for several other applications a narrow bandwidth is desirable if not imperative. Thus, flexibility must be built in the spectrum analyzer. Each of the Hewlett-Packard spectrum analyzers has several selectable IF bandwidths both narrow band and broadband. In addition, the analyzer has three scan modes: (1) Full scan which displays the entire frequency range of the analyzer. (2) Symmetrical (ΔF) scan with several selectable scan widths (narrow and broad). (3) Zero scan in which the analyzer becomes a variable bandwidth tunable receiver. Using the internal time base, the analyzer can be used as a time domain display in this mode, and demodulate AM or FM on a carrier.

Now, let's look at the spectrum analyzer features which will contribute significantly to the measurement capabilities of the spectrum analyzer/tracking generator system.

Sensitivity

Sensitivity is a measure of the analyzer's capability to detect small signals. Like all other receivers, maximum sensitivity is limited by the inherent noise. This noise is bandwidth dependent so that when we reduce the IF bandwidth, the noise level decreases and the analyzer sensitivity improves. The two CRT photographs below demonstrate this characteristic.

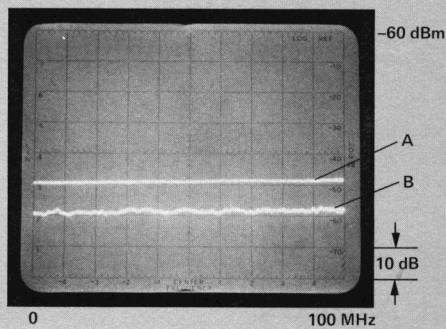

Figure 6. Average Noise Level. Level A is for 30 kHz bandwidth, Level B is for 3 kHz bandwidth.

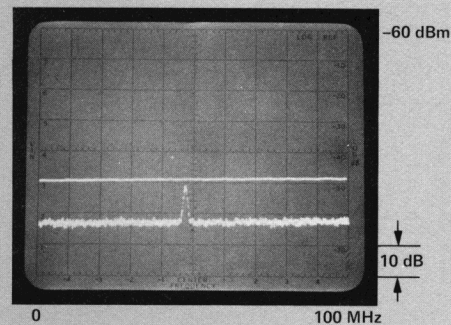

Figure 7. This signal is -111 dB. It was detected with a 1 kHz bandwidth. Notice that it could not be detected with a 30 kHz bandwidth.

Frequency Resolution

In general, frequency resolution is the ability of the analyzer to separate two or more closely spaced signals. Several factors affect the resolution capability of the analyzer; the IF bandwidth is the most significant.

As indicated earlier, the spectrum of a CW signal as displayed on the CRT is a plot of the IF amplifier passband. In other words, the IF amplifier bandwidth is like a "window" which the analyzer uses to look at the frequencies present at its input. Thus, two CW signals with a frequency separation less than the IF amplifier bandwidth would both be in the passband at the same time; hence, they could not be separated. Thus, the narrower the IF bandwidth, the more selective and sensitive the analyzer is.

The skirt characteristics of the IF bandwidth determine the ability of the analyzer to resolve signals differing widely in amplitude. If the skirt is wide, it becomes entirely possible that the response of one signal will obscure or hide a smaller (in amplitude) nearby signal. A shape factor indicating the bandwidth selectivity is normally specified for spectrum analyzers. This factor is usually given as the ratio of

$$\frac{\text{Bandwidth (in Hz) at 60 dB}}{\text{Bandwidth (in Hz) at 3 dB}}$$

The smaller the ratio, the more selective the IF bandwidth is, and the better the resolution capability of the analyzer.

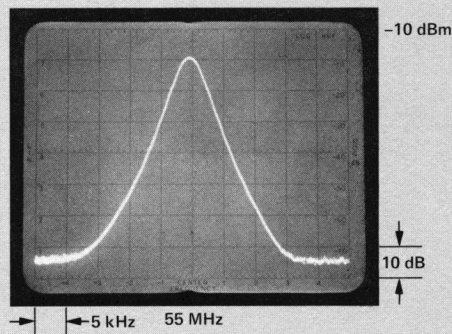

Figure 8. This is the display of a modulated signal. Bandwidth is 3 kHz. Notice that modulation parameters cannot be measured with this bandwidth.

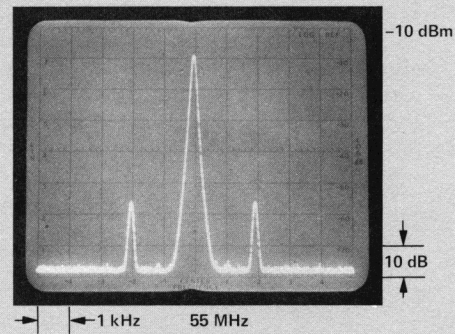

Figure 9. This is the same signal but with 100 Hz bandwidth. Notice the sideband resolution with this narrower bandwidth.

II. THE TRACKING GENERATOR

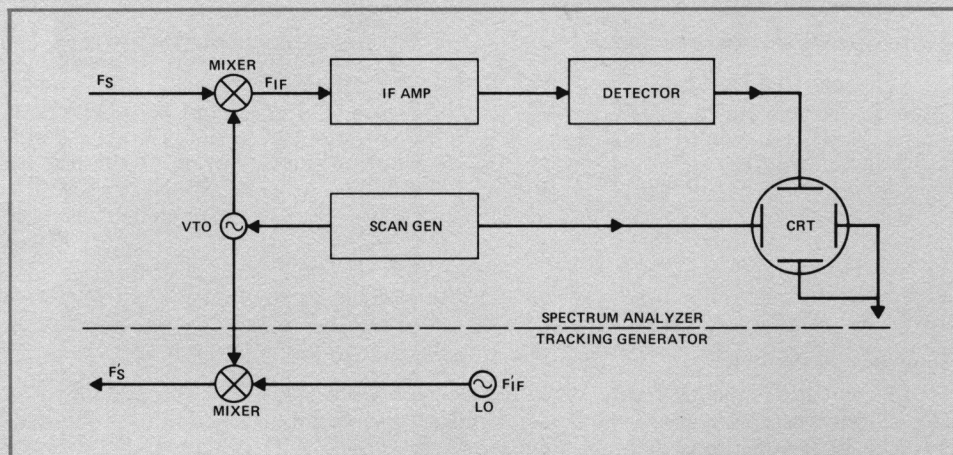

Figure 10. Simplified Spectrum Analyzer/Tracking Generator.

The tracking generator is a special signal source whose RF output frequency tracks (follows) some other signal beyond the tracking generator itself. Usually, the tracking generator output signal is generated by synthesizing and mixing two or more oscillators.

In conjunction with the spectrum analyzer, the tracking generator produces a signal whose frequency precisely tracks the spectrum analyzer tuning. Because of this feature, the two instruments combine to make a powerful and versatile measurement system. However, before going into the measurement capabilities of the system, let's look briefly at the simplified block diagram of a spectrum analyzer/tracking generator shown in Figure 10. The spectrum analyzer portion is the same block diagram described in the previous section.

The tracking generator has a stable, fixed (F'_{IF}) local oscillator. If we make $F'_{IF} = F_{IF}$, then $F_S = F'_S$ where

$$F_S = F_{VTO} - F_{IF} \text{ and } F'_S = F_{VTO} - F'_{IF}.$$

Hence, the tracking generator frequency (F'_s) precisely tracks the spectrum analyzer tuning (F_s), since both are effectively tuned by the same VTO. This precision tracking exists in all three analyzer scan modes. Thus, in full scan, the tracking generator output is a start-stop sweep, in ΔF scan the output is a ΔF sweep, and in zero scan the output is simply a CW signal. Since a flat output level is necessary for swept frequency applications, the tracking generator generally has an internal leveling loop which ensures a flat output level over the entire frequency range of the analyzer.

Open-Loop/Closed-Loop Measurements

The spectrum analyzer/tracking generator system is used in two configurations: open-loop and closed-loop. In the open-loop configuration, unknown external signals are connected to the spectrum analyzer input and the tracking generator output is connected to a counter. This configuration is used for making selective and sensitive precise measurement of frequency. In the closed-loop configuration, the tracking generator signal is fed into the device under test and the output of the device under test is connected to the analyzer input. This configuration is used for making magnitude only swept transmission/reflection measurements; i.e., insertion loss, return loss, SWR, and reflection coefficient. In the following four pages, we will discuss these two configurations without reference to any specific system. Later on, we will show how to make these measurements for each specific spectrum analyzer/tracking generator system separately.

III. OPEN-LOOP SYSTEM: PRECISE MEASUREMENT OF FREQUENCY

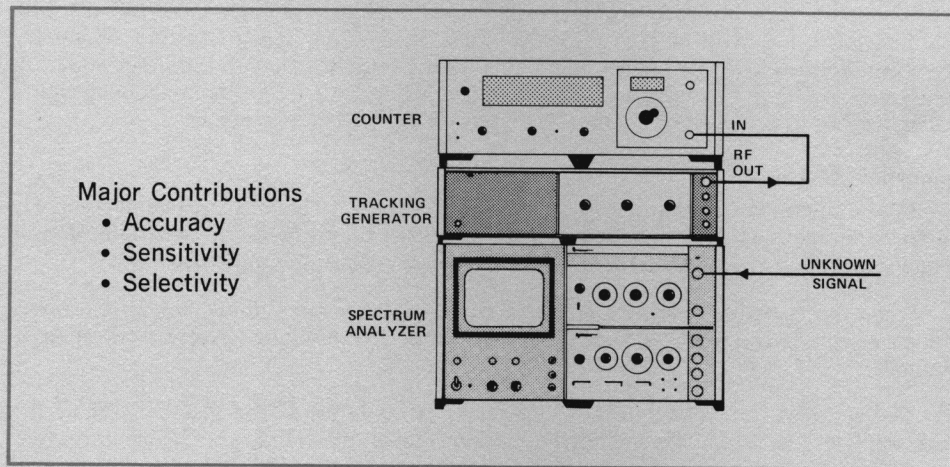

Figure 11. Precise Measurement of Frequency.

Figure 11 is an open-loop configuration where the spectrum analyzer/tracking generator is used as a highly selective, highly sensitive, precision frequency measurement system.

When unknown signals are connected to the analyzer input, they are separated into their frequency components and displayed on the CRT. These signals may be very small and undetectable by a counter or they may be large, but regardless of their level, the tracking generator output is enough to drive the counter. Thus, we can measure the frequency of any signal or component by simply stopping the scan manually or electronically at the peak of that displayed signal and count the tracking generator output frequency. This measurement would not have been possible if precision tracking did not exist between the analyzer tuning and the tracking generator frequency. Figure 12 illustrates this counting procedure.

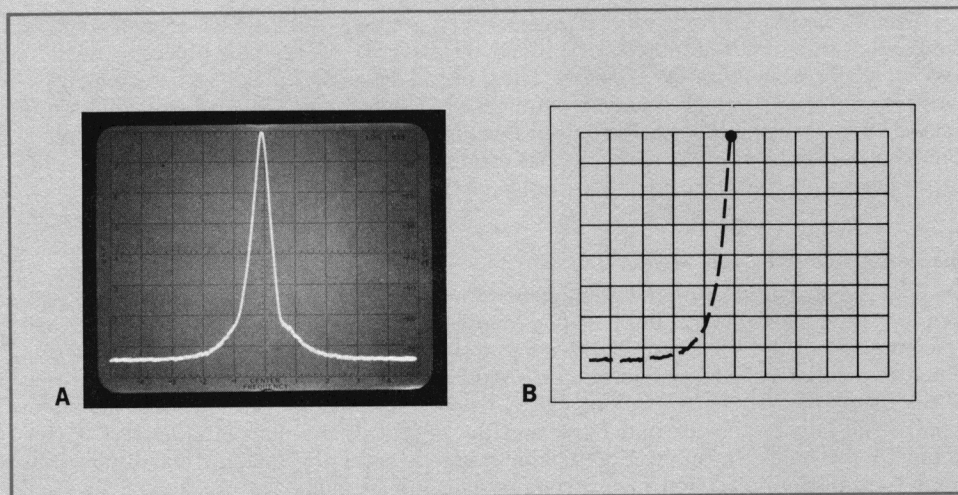

Figure 12. Counting Illustration.

- A. This is the display of a CW signal.
- B. To count the frequency shown in A, stop the scan manually or electronically at the peak of the signal and read the counter display.

The question that should come to mind at this point is, "Why can't we count the unknown signal by connecting it directly to the counter?" A partial answer to this question is yes, we can, but only for spectrally clean, stable, and high level signals. The complete answer will be apparent below when the system sensitivity and selectivity have been considered. But before doing this, let us establish that the indirect counting technique (counting the tracking generator frequency instead of the unknown signal itself) does not diminish the frequency accuracy of the system as a whole.

Frequency Accuracy

In the open-loop configuration, frequency accuracy is limited by two factors: (1) the tracking error which exists between the analyzer tuning and the generator output frequency, and (2) the residual FM of the tracking generator output frequency.

Since the tracking generator precisely tracks the analyzer tuning, tracking error is seldom worse than a few parts per million. Thus, the tracking error contribution is minimal.

The residual FM of the tracking generator is made up of the residual FM of the local oscillators in the analyzer and the tracking generator. These oscillators have very low residual FM, due to internal stabilization. Hence, the contribution of the residual FM of the tracking generator signal is also minimal.

From this we can see that counting the tracking generator frequency instead of the unknown signal itself is potentially highly accurate.

Sensitivity

Any signal displayed on the analyzer CRT, from the analyzer burnout to the noise level, can be counted. This simply means that we have a counting system with a sensitivity identical to that of the analyzer.

The significance of the tracking generator in this application is that its output level is sufficient to drive a counter regardless of the level of the unknown signal, and therefore it effectively transfers the analyzer sensitivity to the counter. Furthermore, since the analyzer sensitivity is bandwidth dependent, we can increase our sensitivity by narrowing the analyzer's IF bandwidth. We can display very small signals on the order of tens of nanovolts (10^{-9}) and count their frequency. By contrast to a stand alone

counter, this sensitivity far exceeds available counter sensitivity and is equivalent to about 60 to 70 dB improvement.

Selectivity

The spectrum analyzer has several scan widths and several IF bandwidths, both ranging from very narrow to very broad. By adjusting the scan width, you can control the portion of the spectrum being scanned and displayed on the CRT; and by adjusting the IF bandwidth, you can control the minimum separation required for resolving two closely spaced signals.

Another facet of interest is that the analyzer is amplitude-selective through its filter skirt. Signals differing in amplitude by as much as 70 dB and separated by a minimum frequency can be resolved and displayed simultaneously.

The spectrum analyzer/tracking generator makes a highly selective frequency measurement system. The end limitation to selectivity is what you can resolve on the CRT. Here again, if you can resolve a signal, you can measure its frequency; simply stop the scan manually or electronically at the peak of the desired signal and read the counter display.

In summary, we see that the fundamental signal, harmonics, sidebands (including FM and PM signals), and non-random spurious signals can be indirectly counted by adjusting the analyzer scan width and IF bandwidth. In this application, the counter effectively acquires the sensitivity and selectivity of the spectrum analyzer. The conventional counter, by contrast, is triggered by the highest level signal, thus affording little sensitivity and selectivity, if any.

IV. CLOSED-LOOP SYSTEM: SWEEPED FREQUENCY MEASUREMENT (DEVICE CHARACTERIZATION)

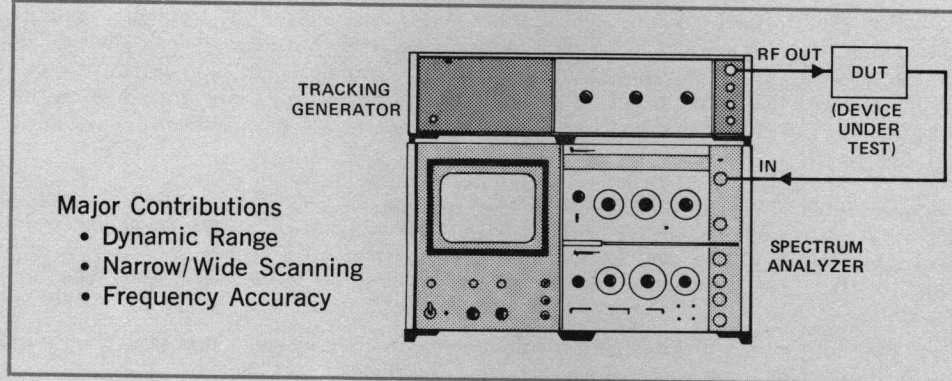

Figure 13. Swept Frequency Measurements.

In this configuration, the spectrum analyzer/tracking generator becomes a self-contained, complete (source, detector, and display) swept frequency measurement system. An internal leveling loop in the tracking generator ensures a leveled output over the entire frequency range. The specific swept measurements that can be made with this system are frequency response (amplitude vs. frequency), magnitude only reflection coefficient, and return loss. From return loss or reflection coefficient, we can calculate the SWR. Swept phase and group delay measurements cannot be made with this system; however, it does make some unique contributions not made by other swept systems, such as a sweeper/network analyzer, a sweeper/spectrum analyzer, or a sweeper/detector/oscilloscope.

The spectrum analyzer/tracking generator has three attractive features:

1. Large amplitude dynamic range
2. Narrow/wide scan widths
3. Excellent frequency accuracy

Each of these features is discussed separately on the following pages.

Amplitude Dynamic Range

The measurement dynamic range of the spectrum analyzer/tracking generator may exceed 120 dB. The key to this large dynamic range is the precision tracking which exists between the analyzer tuning and the generator RF output frequency. This precision tracking permits over-driving the mixer to the 1 dB compression level while keeping the analyzer distortion products off the CRT.

Precision tracking means at every instant of time the generator fundamental frequency is in the center of the analyzer passband, and all generator harmonics, whether they are generated in the analyzer or are produced in the tracking generator itself, are outside the analyzer passband. Thus, only the tracking generator fundamental frequency is displayed on the analyzer's CRT. Second and third order harmonics and intermodulation products are clearly out of the analyzer tuning and, therefore, they are not seen. Thus, while these distortion products *may exist* in the measurement set-up, they are completely *eliminated* from the CRT display.

The 1 dB gain compression level is a point of convenience, but it is nonetheless considered the upper limit of the dynamic range. The lower limit, on the other hand, is dictated by the analyzer sensitivity which, as we know, is bandwidth dependent. The narrowest usable bandwidth in turn is limited by the tracking generator residual FM and any tracking drift between the analyzer tuning and the tracking generator signal.

The measurement dynamic range obtained with most other techniques does not exceed 60 to 80 dB, whether a network analyzer, a spectrum analyzer, or a detector/oscilloscope is used for detection and display. The limitation differs with each display. For the network analyzer, the limitation is noise generated in the analyzer channels; for the spectrum analyzer, it is distortion created in the spectrum analyzer by the sweeper signal; and for the detector/oscilloscope, it is the detector square law operation.

Narrow/Wide Scan Widths

Because of precision tracking, the tracking generator output frequency acquires the same scan capability as the spectrum analyzer. Hence, the analyzer's several calibrated scan widths which range from broadband to extremely narrow band are acquired by the tracking generator. However, it is the tracking generator's inherently low residual FM (<1 Hz below 110 MHz, <200 Hz above) which makes narrow scanning meaningful and usable.

The large dynamic range discussed above makes the narrow scan capability particularly significant. Very narrow band, high "Q" devices can be swept frequency tested with excellent amplitude and frequency resolution. The wide scan width capability, on the other hand, makes it possible to view the frequency response over a wide frequency range.

By contrast, the residual FM of most conventional sweepers is a few kHz (3-10 kHz); thus it precludes very narrow band measurements.

Frequency Accuracy

In the closed-loop configuration, the CRT displays the frequency response of the device under test. Frequency accuracy in this configuration means the ability to identify and measure the frequency of any point on the CRT display.

The amplitude dynamic range and the scan capability of the spectrum analyzer/tracking generator make identification of any point on the display quite easy and unambiguous. Thus, we can identify the 3 dB points, 60 dB points, center frequency, etc. The frequency of any point on the display is measured by connecting a counter to the tracking generator output and stopping the scan (manually or electronically) at the point of interest.

The accuracy of this measurement is limited by the tracking generator residual FM plus the counter's own accuracy. Excluding the counter contribution, this accuracy ranges from 3 to 400 Hz for Hewlett-Packard spectrum analyzer/tracking generator systems. By comparison, the accuracy obtained from counting most conventional sweepers varies from 3 to 10 kHz. Here again, the limitation is the sweeper residual FM, which is usually several orders of magnitude greater than that of the tracking generator.

It should be pointed out that the frequency accuracy in the closed-loop configuration is dependent upon the frequency tracking between the spectrum analyzer and tracking generator. To see why this is true, let us consider the case where tracking is deliberately degraded. When tracking is degraded, the tracking generator frequency shifts from the center of the IF bandwidth and the analyzer response decreases in amplitude and shifts in frequency. This frequency shift is a result of tracking error and is typically negligible when using wide sweep widths. However, when making swept response measurements on narrow band devices, it is important that the spectrum analyzer and tracking generator track precisely.

The CRT photograph in Figure 14B demonstrates this result. Curve A is the frequency response of a bandpass filter and is taken at maximum tracking. Curve B is for the same filter, but tracking has been deliberately degraded. Notice how in Curve B the entire display has shifted in amplitude (downward) and frequency. The relative positions of the center frequency, 3 dB points, 60 dB points, etc. are still preserved but shifted relative to the horizontal scale. This is true because we are counting the frequency of the applied stimulus; i.e., the same response must always occur at the same stimulating frequency.

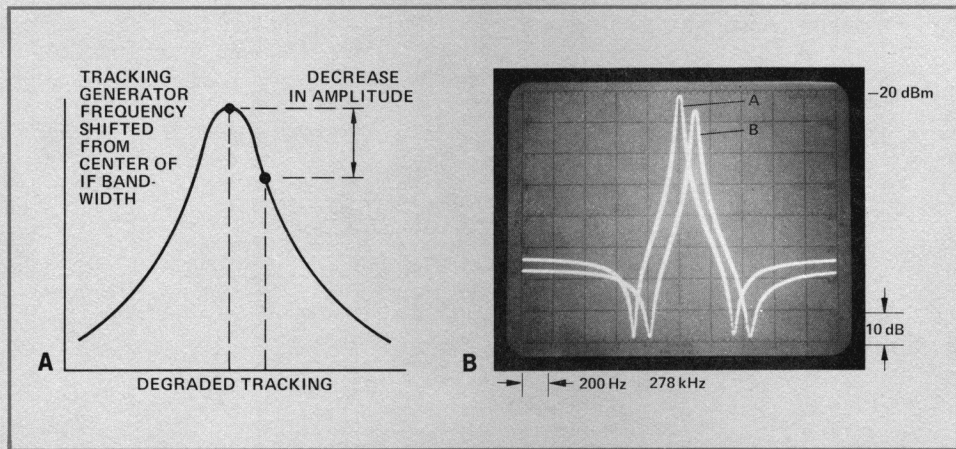
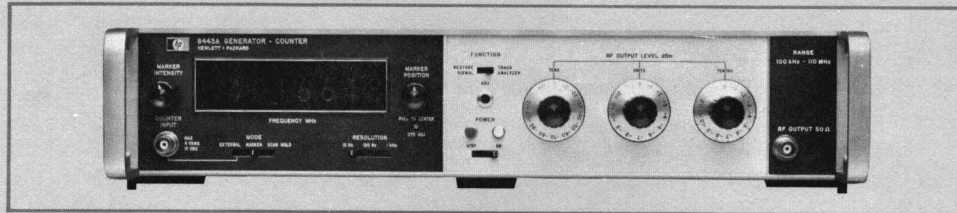

Figure 14. Degraded Tracking Effect.

- A.** The tracking generator frequency shifted from the center of the IF bandwidth.
- B.** CRT display with maximum and degraded tracking.

CHAPTER 3
THE 8443A TRACKING GENERATOR
100 kHz - 110 MHz



- Residual FM <math>< 1\text{ Hz}</math>
- Tracking Error <math>< \pm 10\text{ Hz}</math>
- Built-in Counter

I. PRECISE MEASUREMENT OF FREQUENCY

Capabilities:

Frequency Accuracy: Counter Accuracy (Restore Signal function)
 $\pm 10\text{ Hz} + \text{Counter Accuracy (Track Analyzer function)}$
 Sensitivity: -140 dBm
 Selectivity: 10 Hz

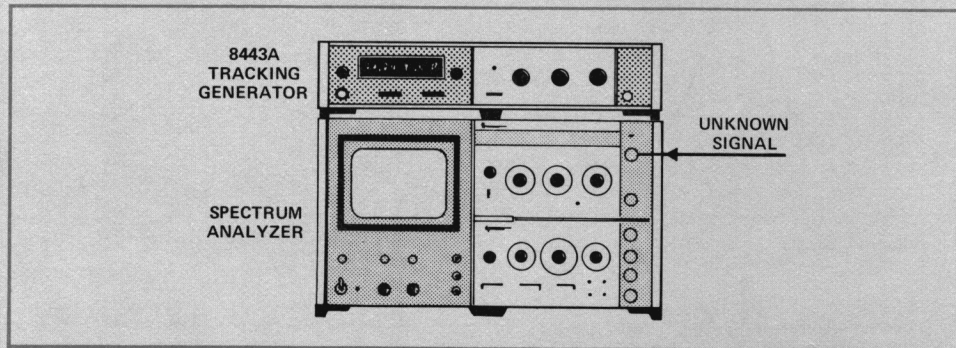

Figure 15. Frequency Counting with the 8443A.

Equipment Needed: 8443A, 8553B, 8552B, 141T.*

The 8443A is the most versatile tracking generator. It has two functions: "Track Analyzer" and "Restore Signal"; the latter is rather unique to the 8443A. In both functions, this tracking generator can count the frequency of an unknown signal; however, there are enough differences between them to treat each function separately.

"Track Analyzer" Function

Counting in this function is controlled by the Mode switch and the Marker Position knob. The Mode switch selects one of three counting modes—External, Marker, or Scan Hold—while the Marker Position knob simply moves a marker generated by the 8443A and used to select for counting any signal displayed on the CRT.

At this point, it would be helpful to see how counting is actually done. We can do this by considering how the marker is generated. During each scan cycle, the analyzer scanning pauses momentarily at a predetermined position (in Scan Hold scanning stops

* Wherever a 141T is listed in the equipment needed, a 140T or 143S may be used instead; and likewise, an 8552B may be replaced by an 8552A, except as noted.

indefinitely). This pause (or stop) causes two things to happen: (1) the counter gate opens and samples the frequency of the tracking generator, and (2) a bright spot (hence, a marker) shows on the CRT; this spot identifies where the counter reading was made.

To count an unknown signal, connect it to the analyzer and obtain an amplitude calibrated CRT display using the blue-coded portion of the scan width control; i.e., zoom-in on the signal with narrow scanning and narrow bandwidth. If maximum sensitivity and/or selectivity are desired, the 10 Hz bandwidth should be used and, in general, the Scan Hold Mode should be used with the 10 Hz and 30 Hz bandwidths since it greatly facilitates the measurement procedure. In this mode, we can move the marker to the peak of the desired signal where the scan stops, observe its location on the CRT, and read the frequency continually.

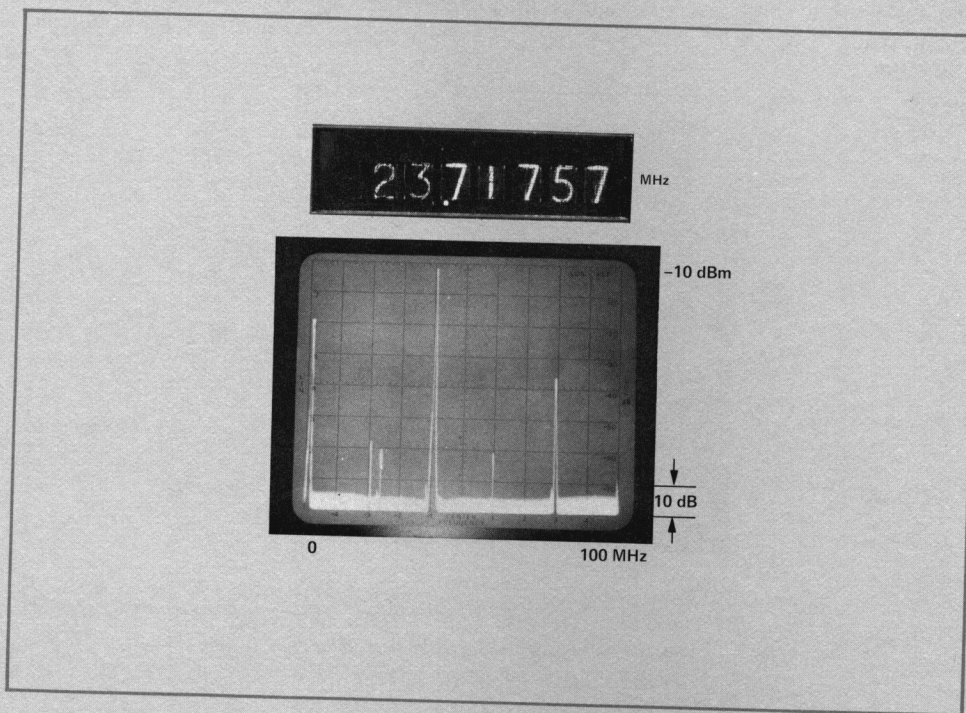

Figure 16. "Track Analyzer" Function: This CRT display shows several signals. The smallest signal (-70 dBm) was counted by placing the marker at its peak.

"Restore Signal" Function

This function has two advantages; it provides better frequency accuracy (exact counter accuracy) and it is easier to count with since accuracy does not require zooming-in on the signal. Its sensitivity, however, is approximately 15 dB worse than the "Track Analyzer" function.

In the "Track Analyzer" function, the 8443A RF output is synthesized from the analyzer three local oscillators and an internal 3 MHz crystal oscillator (see Appendix). In the "Restore Signal" function, the 3 MHz oscillator is turned off and the analyzer 3 MHz IF signal is inserted instead. This means that the 8443A reconstructs (restores) the unknown signal by a heterodyning process which is simply the exact reversal of that of the analyzer, and thus the signal at the tracking generator output is identical to the signal at the analyzer input. This process eliminates any tracking errors, hence frequency accuracy is equal to the counter's own accuracy, an improvement equal to ± 10 Hz over the "Track Analyzer" function.

In the "Restore Signal" function, if a signal is not connected to the analyzer input, the tracking generator output resembles noise since there is no signal to restore. In this condition, it makes no difference where the marker is, the counter will not be properly triggered. Furthermore, if a signal is connected to the analyzer, but the marker is close to the noise level, the counter will not be triggered. In both cases the counter is set to trigger at the frequency where the marker is located, but only noise is present at that frequency. The counter will be triggered, however, if the marker is typically 15 dB above the noise.

Zooming-in on the unknown signal is not required; the signal frequency can be measured even in wide scan widths. Simply connect the signal to the analyzer input and obtain an amplitude calibrated CRT display. Position the marker 15 dB above the noise anywhere on the skirt of the signal and read the counter display. To improve sensitivity and/or selectivity, the analyzer IF bandwidth should be reduced. For example, at 100 Hz IF bandwidth, a signal of -115 dBm can be counted since the analyzer sensitivity is -130 dBm.

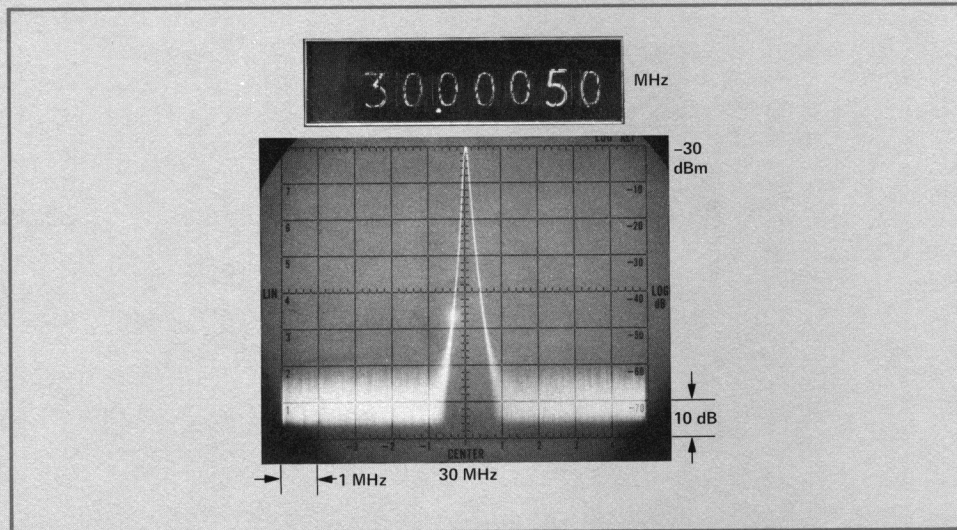

Figure 17. "Restore Signal" Function: This signal was counted to counter accuracy by placing the marker approximately 15 dB above the noise.

II. SWEEPED FREQUENCY MEASUREMENTS*

Capabilities:

Dynamic Range: >120 dB
Frequency Accuracy: ± 10 Hz + Counter Accuracy
Scan Width: 200 Hz to 100 MHz

A. Insertion Loss/Gain

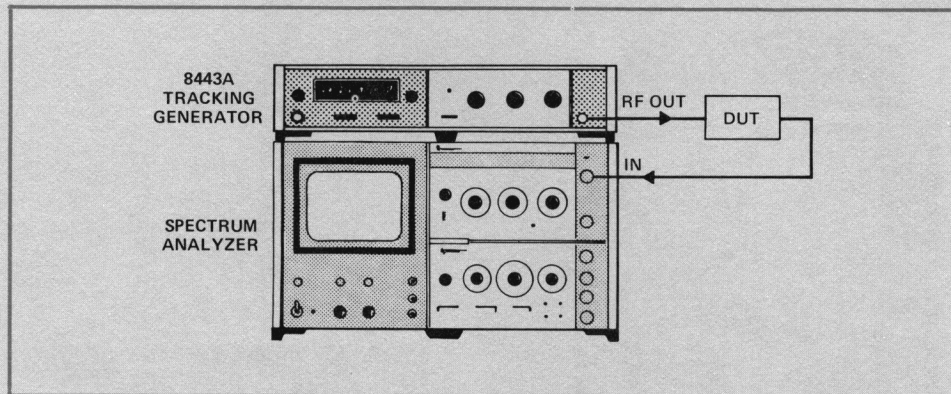

Figure 18. Frequency Response—
Insertion Loss with the 8443A.

Equipment Needed: 8443A, 8553B, 8552B, 141T.

Since the analyzer sensitivity is -110 dBm, greater than 120 dB dynamic range can be realized using the following settings:

RF Output: +10 dBm
Input Attenuation: 20 dB
Bandwidth: 10 kHz or narrower
Log Reference Level: +10 dBm

The 20 dB input attenuation reduces the analyzer gain compression level to <1 dB. At narrower IF bandwidths, sensitivity increases, thus increasing the dynamic range. For example, at 100 Hz bandwidth, sensitivity is -130 dBm so the dynamic range is 140 dB. At this bandwidth, however, the analyzer has to be stabilized; i.e., at scan width/division of 20 kHz or less. Maximum dynamic range of 150 dB can be obtained with the 10 Hz bandwidth, from +10 dBm to -140 dBm. If scans wider than 20 kHz/division and greater than 120 dB dynamic range are desired, the 1 kHz IF bandwidth should be used since at this bandwidth the analyzer residual FM is <1 kHz and the average noise level is -120 dBm.

In the usual spectrum analyzer applications, the display uncalibrated light status depends entirely on the analyzer settings; i.e., bandwidth, scan width per division, and scan time per division. Thus, if the settings are correct, the light is OFF and the analyzer is amplitude calibrated. In the closed-loop measurement, however, the light cannot be used as an indicator. This is so because amplitude calibration depends among other things on the effective scan rate (Hz/sec) of the analyzer and the *bandwidth* of the device under test. Thus, for example, if the analyzer is amplitude calibrated at a 300 Hz bandwidth, and a 1 kHz bandwidth device is measured, the analyzer remains calibrated. But measuring a 100 Hz bandwidth device under the same conditions may result in an uncalibrated frequency response although the light remains OFF. Therefore, to calibrate the analyzer, insert the device under test in the system, set up scan width and IF bandwidth and gradually increase scan time until the display amplitude remains constant with changes in scan time. At this point, the scan rate satisfies the requirements of both the analyzer and the device under test.

* The "Restore Signal" function cannot be used in this configuration.

In this application, the 8443A Mode switch and Marker position knob can be similarly used to count the frequency of any point on the frequency response curve of the device under test.

The output attenuators of the 8443A can be used for precision (0.1 dB) RF substitution measurements. This capability will be shown below in measuring the 3 dB bandwidth of a passband filter. Devices as narrowband as 10 Hz can be tested with the 8443A.

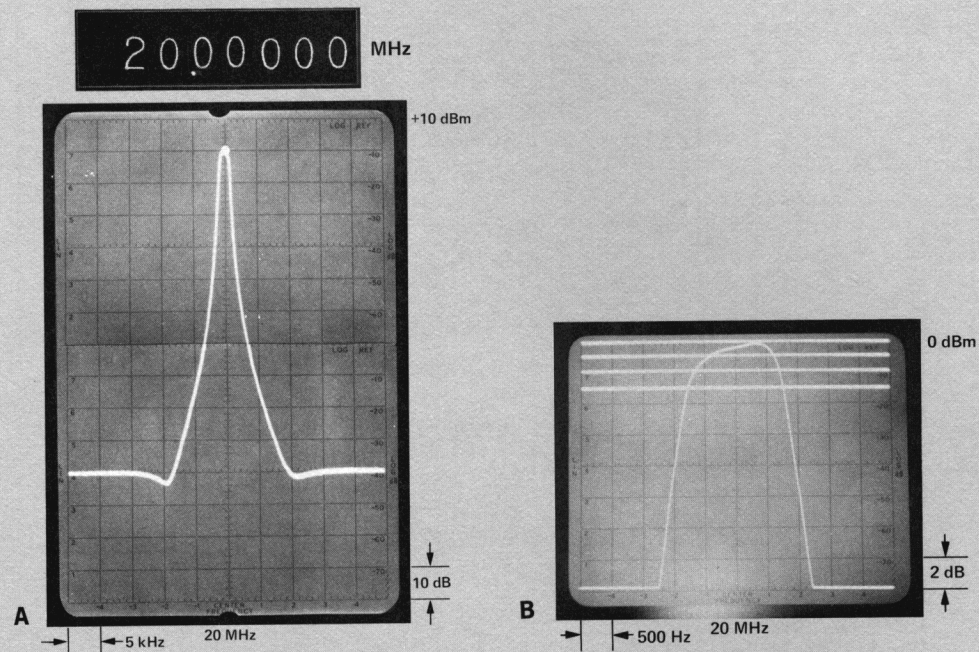

Figure 19. Filter Response.

- A.** This photograph shows the response of a passband filter over a range greater than 100 dB. It is actually two photographs stacked vertically. One photograph was taken at +10 dBm Log Ref Level, while the other was taken at -60 dBm. The passband center frequency was counted. From the latter measurement, the 60 dB bandwidth was determined to be 7.02 kHz.
- B.** This photograph shows the passband details of the same filter. Precision calibration lines were drawn using the 8443A attenuators.

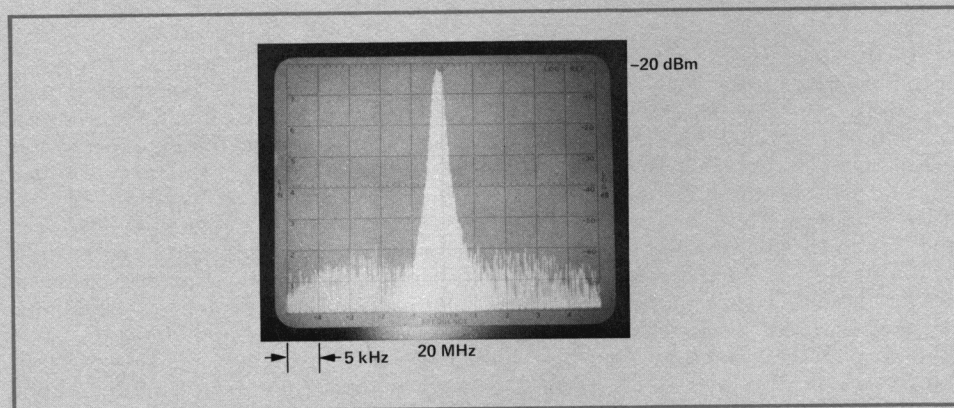

Figure 20. This is a CRT display for the same filter using a conventional sweeper.

B. Return Loss

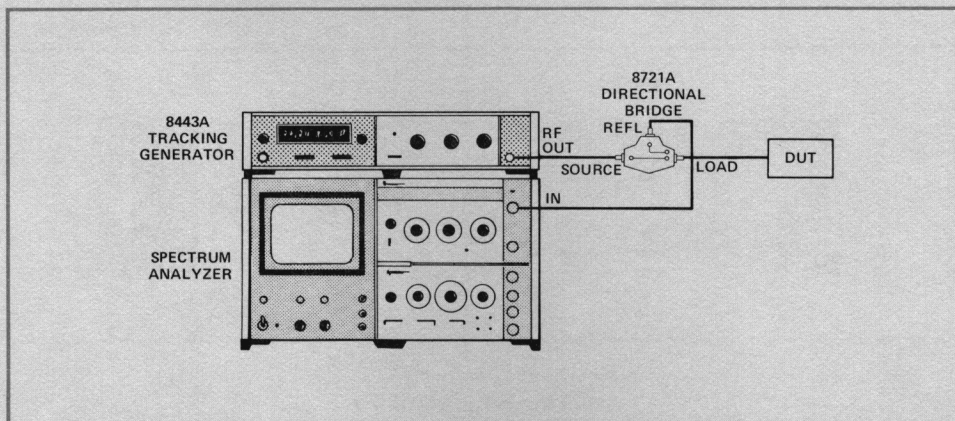

Figure 21. Return Loss Measurement with the 8443A.

Equipment Needed: 8443A, 8553B, 8552B, 141T, Directional Bridge (8721A), BNC Short (1250-0929), 50 Ω BNC Termination (11652-60001).

A directional bridge, the HP 8721A, is used to separate the reflected signal from the incident signal as shown in the diagram above. The 8721A has good directivity (>40 dB). This high directivity is necessary for this measurement because the higher the directivity, the larger the return loss that can be measured, and thus the lower the reflection coefficient. A directional coupler may be used instead of the 8721A, but the coupler should have comparable directivity.

To make return loss measurements, the CRT is calibrated so that the top graticule line represents 0 dB return loss; i.e., $\rho = 1$ or 100% reflection. This is done by placing a short at the 8721A Load terminal and adjusting the Log Reference Level and its vernier. The device under test is then placed at the 8721A Load terminal and the device is terminated in its characteristic impedance.

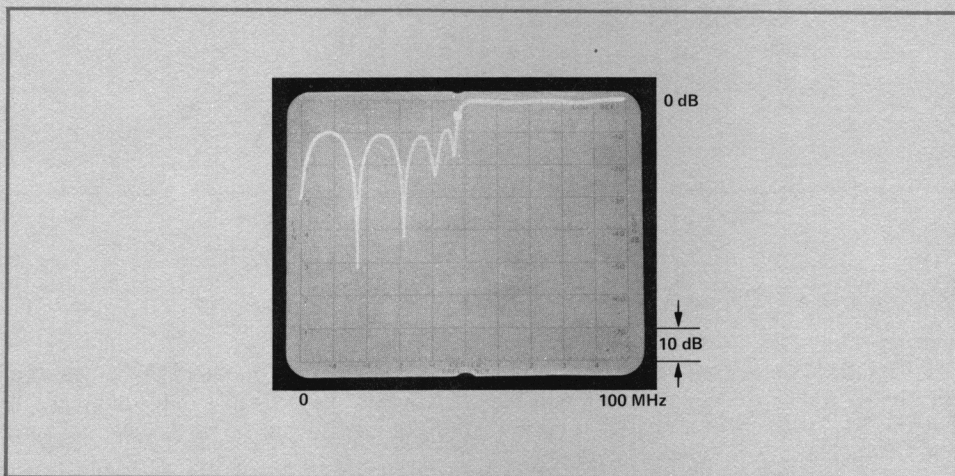
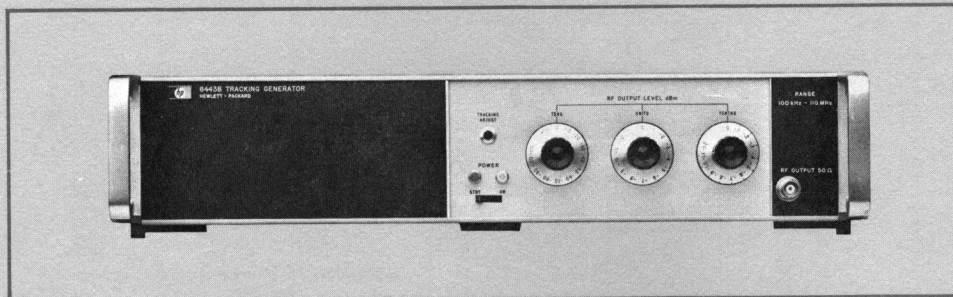

Figure 22. This photograph shows the return loss of a 50 MHz low pass filter. The top graticule line of the CRT was calibrated for zero dB return loss; i.e., $\rho = 1$. Notice how the filter rejects everything above 50 MHz by reflecting it back.

THE 8443B TRACKING GENERATOR 100 kHz - 110 MHz



- Residual FM <math>< 1\text{ Hz}</math>
- Tracking Error <math>< \pm 10\text{ Hz}</math>
- External Counter Required

The 8443B measurement capabilities are identical to the 8443A, except the "Restore Signal" function which is not available with the 8443B.

I. PRECISE MEASUREMENT OF FREQUENCY

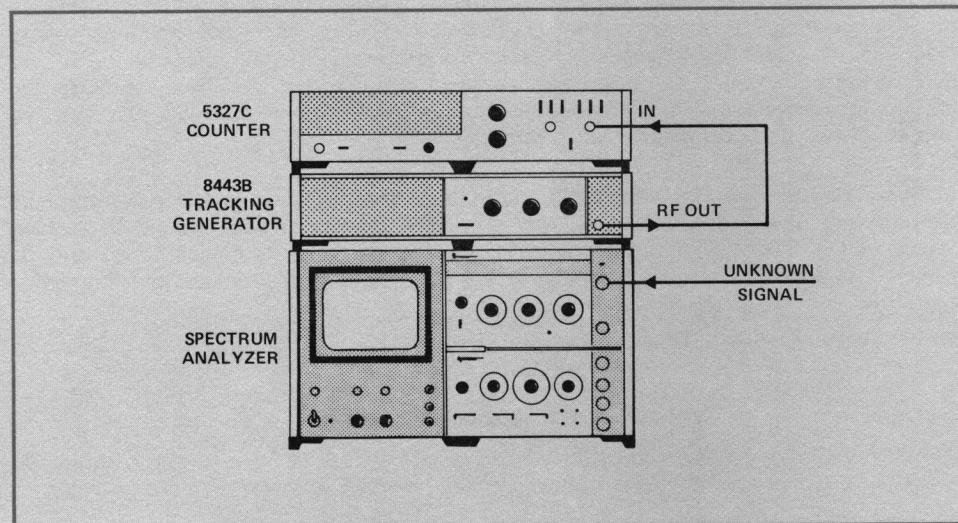

Figure 23. Frequency Counting with the 8443B.

Equipment Needed: 8443B, 8553B, 8552B,* 141T, 50 Ω Counter (5300A/5303B or 5327C).

The 8443B has only the tracking generator portion of the 8443A; sensitivity, selectivity, and frequency accuracy are the same as the 8443A. The only difference is that the 8443B requires an external counter and the analyzer to be in the manual scan mode to make any frequency measurements.

The frequency of an unknown signal can be counted with any 50 Ω counter. This is done by displaying the signal on the CRT and manually scanning the analyzer, stopping at the peak of the desired signal. The counter read-out is the frequency of the desired signal.

* If the 8552A is used, an external scan ramp with manual scan control is required for frequency counting.

II. SWEEPED FREQUENCY MEASUREMENTS

A. Insertion Loss

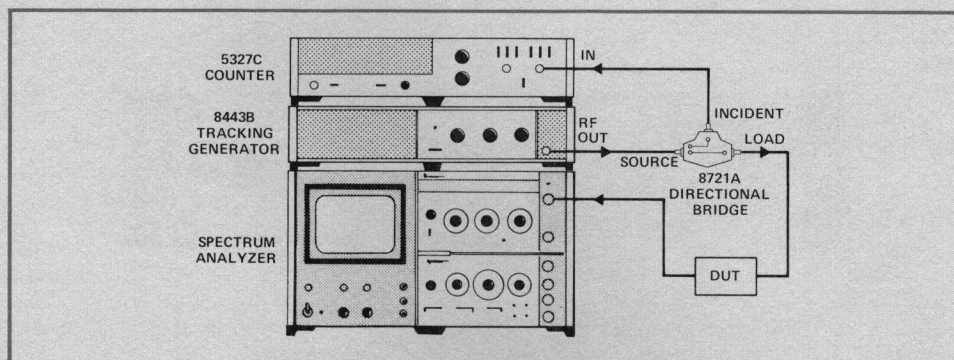

Figure 24. Frequency Response with the 8443B.

Equipment Needed: 8443B, 8553B, 8552B, 141T, Directional Bridge (8721A), 50 Ω Counter (5300A/5303B or 5327C).

In this set-up, the 8721A is used as a power divider of the tracking generator output. A portion goes to the counter and an equal portion goes to the device under test.

If used with the 8721A as shown in the diagram above, the 8443B dynamic range is 6 dB less than the 8443A; this is due to approximately 6 dB loss in the 8721A. The uncalibrated light cannot be used as an indicator, so to amplitude calibrate the system, scan time must be increased until the amplitude remains constant with any change in scan time.

To count the frequency of any point on the display, simply manually scan the analyzer to that point and read the counter readout.

B. Return Loss

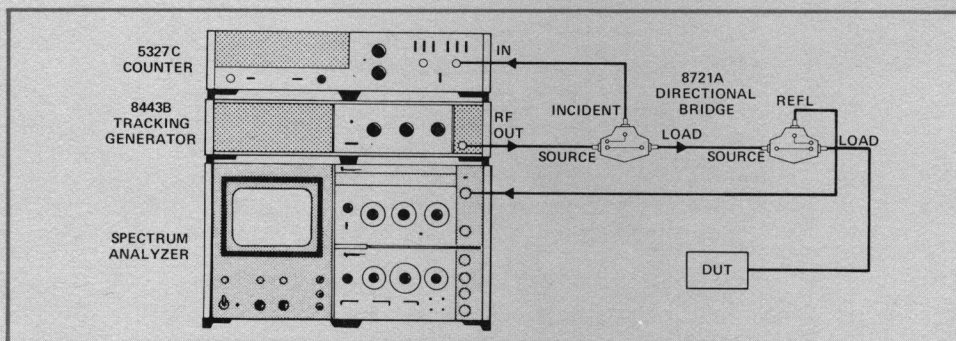

Figure 25. Return Loss Measurement with the 8443B.

Equipment Needed: 8443B, 8553B, 141T, 8721A (2 ea.), 5300A/5303B or 5327C, BNC Short (1250-0929), 50 Ω BNC Termination (11652-60001).

In the set-up shown, the first 8721A is used to sample the tracking generator output for counting, while the second 8721A is used to separate the reflected signal from the incident signal.

The procedure to make return loss measurement is identical to the procedure used with 8443A. Calibrate the top graticule line for 0 dB return loss with a short and then connect the device under test and terminate it in its characteristic impedance.

To count the frequency of any point on the CRT, simply manually scan the analyzer to that point and read the counter display.

CHAPTER 4

THE 8444A TRACKING GENERATOR 500 kHz - 1300 MHz

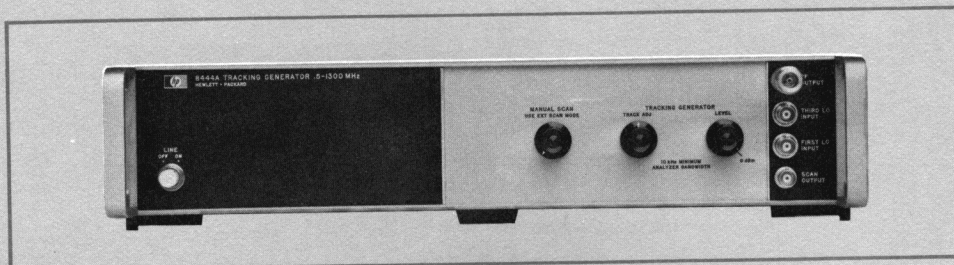

- Operates with the 8554B (0.5 - 1250 MHz) and the 8555A (10 - 1300 MHz) also can be used with the 8558B (0.5 - 1300 MHz) when Option 058 is installed. See 8558B data sheet for details.
- Residual FM <200 Hz (8554B)
<200 Hz (8555A)
<1100 Hz (8558B)
- External Counter Required

I. PRECISE MEASUREMENT OF FREQUENCY

Capabilities:

Frequency Accuracy: ± 10 kHz* + counter accuracy

Sensitivity: -117 dBm (8554B)
-125 dBm (8555A)
-117 dBm (8558B)

Selectivity: 100 Hz (8554B)
100 Hz (8555A)
1 kHz (8558B)

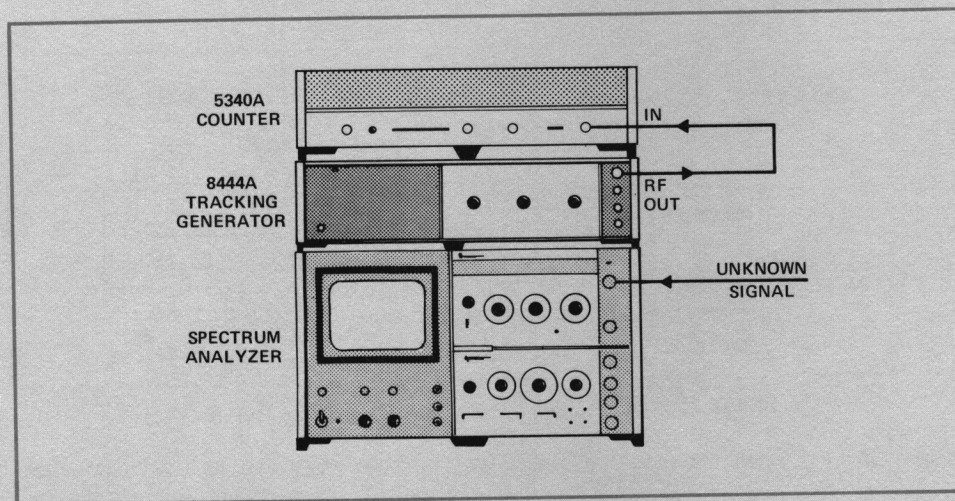

Figure 26. Frequency Counting with the 8444A.

Equipment Needed: 8444A, 8554B, or 8555A, 8552B, 141T,** Counter (5340A or 5341A).

* Refer to Chapter 6, Beat Frequency Technique, to improve the 8444A accuracy to ± 200 Hz.
** Wherever a 141T is listed in the equipment needed, a 140S or a 143S may be used instead; and likewise, an 8552B may be replaced by an 8552A, except as noted. 8558B/182T can be used with 8444A Option 058 instead of 8554B or 8555A Spectrum Analyzer systems.

Each of the analyzers used with the 8444A has four local oscillators; however, the 8444A output frequency is synthesized from only two of these oscillators and a 1.55 GHz cavity oscillator in the 8444A itself. Since the 8444A does not synthesize all of the analyzer local oscillators, a frequency offset (drift) develops between the analyzer tuning and the 8444A output frequency. This offset is on the order of a few kHz and is the major source of error in this measurement. Moreover, you can disregard the recommended 10 kHz minimum bandwidth in this measurement, the warning on the front panel applies for swept frequency measurements only, as explained under "Insertion Loss/Gain" below. In fact, 100 Hz and 200 Hz bandwidths must be used to resolve and count close-in sidebands or signals.

To count the frequency of an unknown signal, connect it to the analyzer and obtain an amplitude calibrated CRT display, utilizing the blue-coded portion of the scan width control. Switch the analyzer scan mode to External and with the 8444A Manual Scan knob, the analyzer is manually scanned to the peak of the signal of interest. The counter display is the frequency of the signal ± 10 kHz. This accuracy represents a 1000:1 improvement over the analyzer dial accuracy for the 8554B and 2000:1 improvement over the 8555A dial.

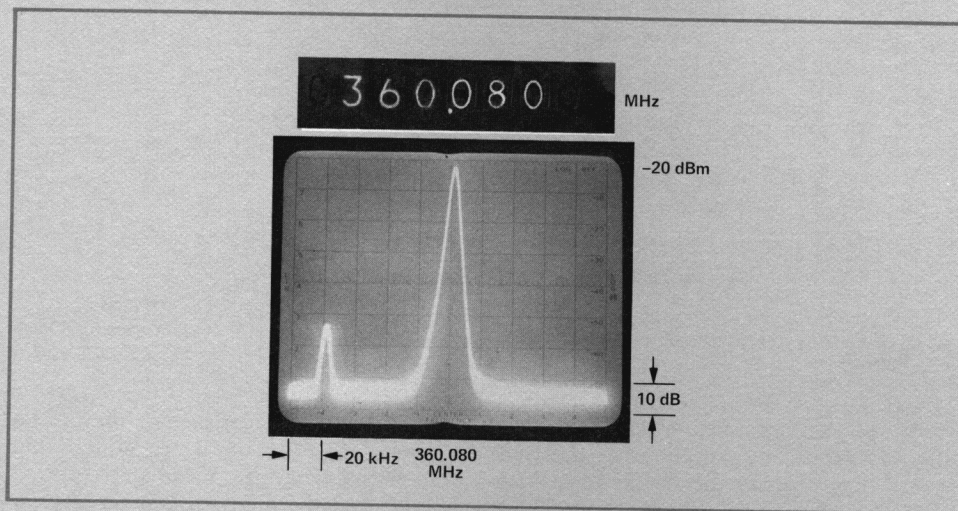

Figure 27. This photograph shows a sideband 80 kHz away. Bandwidth is 3 kHz. The sideband frequency was counted as 360.080 MHz.

II. SWEEPED FREQUENCY MEASUREMENTS

Capabilities

Dynamic Range: >90 dB
Frequency Accuracy: ± 200 Hz + counter accuracy (8554B)
 ± 200 Hz + counter accuracy (8555A)
 ± 1 kHz + counter accuracy (8558B)
Scan Width: 20 kHz to 1250 MHz (8554B)
20 kHz to 1290 MHz (8555A)
50 kHz to 1000 MHz (8558B)

A. Insertion Loss/Gain

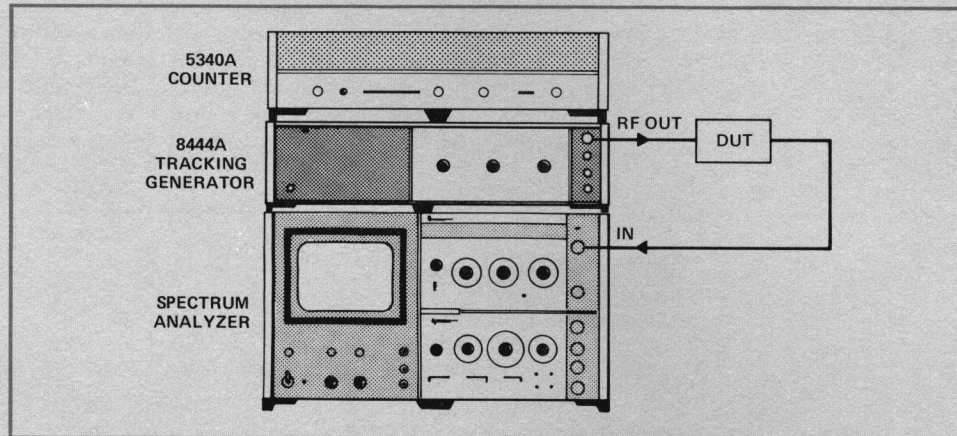

Figure 28. Frequency Response with the 8444A.

Equipment Needed: 8444A, 8554B or 8555A, 8552B, 141T, Counter (5340A or 5341A), Attenuator (355C optional).

In this configuration, we are concerned with the frequency response of the device under test, thus any variations in the tracking generator output level are undesirable because they obscure the test results. Such variations may be introduced if frequency drift or tracking error between the tracking generator and the analyzer tuning exceeds the IF bandwidth. This explains why 10 kHz is the minimum recommended analyzer IF bandwidth to be used in swept frequency measurements.

Greater than 90 dB dynamic range can be obtained using a 0 dBm signal level out of the 8444A. This signal, however, should be attenuated 10 dB at the analyzer input to keep the gain compression <1 dB.

Now by setting the Log Reference level at 0 dBm, we have a dynamic range that extends 102 dB for the 8554B and 105 dB for the 8555A (sensitivity for the 8554B and 8555A at 10 kHz bandwidth is -102 dBm and -105 dBm, respectively).

As explained earlier in Chapter 3 (page 15), the display uncalibrated light cannot be used as an indicator in this measurement. Instead, the analyzer scan time should be increased until no change in amplitude is observed on the CRT with any increase in scan time.

Devices as narrowband as 1 kHz can be swept frequency tested with this system. The ultimate limitation here is the residual FM of the tracking generator signal and what the eye can resolve on the CRT.

To count the frequency of any point on the CRT, switch the analyzer scan mode to External and with the Manual Scan knob of the 8444A, manually scan to the point of interest. The counter display is the frequency of this point, ± 200 Hz. This is an easy measurement to do and this frequency accuracy is possible because it is independent

of tracking error between the generator frequency and the analyzer tuning as shown in Figure 14B. The 200 Hz is the residual FM of the tracking generator signal.

The HP 355C is a 12 dB step attenuator in 1 dB steps. It can be used to make RF substitution measurements. Calibration lines for 3 and 6 dB down can be established on a variable persistence CRT; these lines provide accurate identification of the 3 dB and 6 dB points.

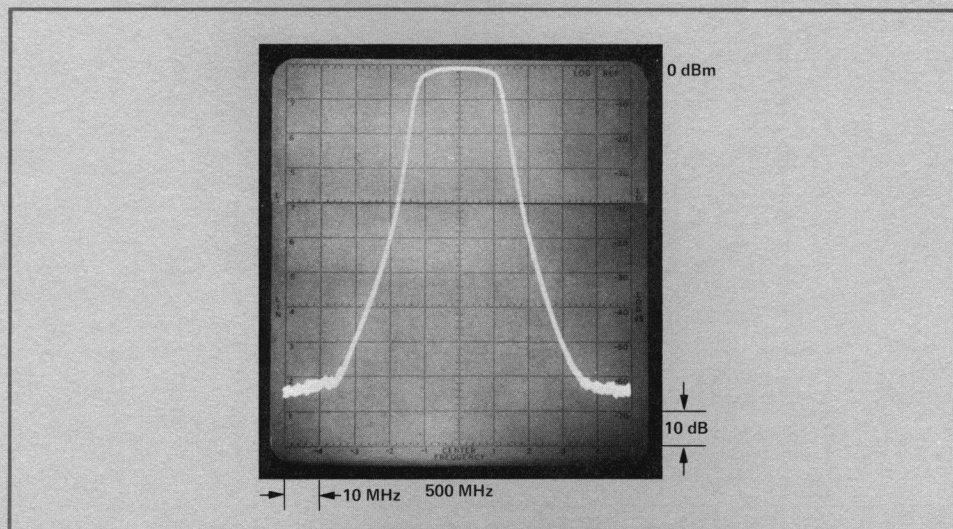

Figure 29. This CRT photograph shows the frequency response of a 500 MHz bandpass filter over a range greater than 90 dB. It consists of two CRT photographs stacked vertically. One photo was taken at 0 dBm and the other at -30 dBm.

B. Return Loss

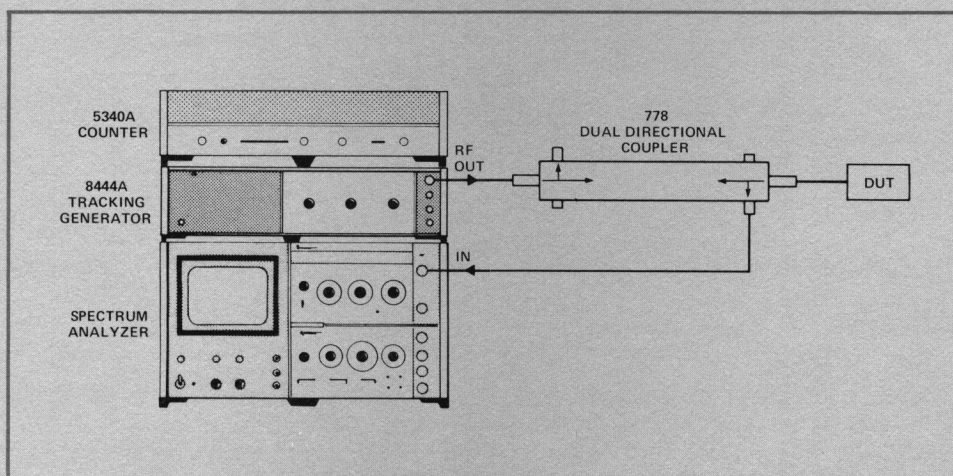

Figure 30. Return Loss Measurement with the 8444A.

Equipment Needed: 8444A, 8554B or 8555A, 8552B, 141T, Counter (5340A or 5341A), Directional Coupler (778D), Directional Bridge (8721A), 50 Ω Terminator (11652-60001 BNC, 908A N), Short (1250-0929 BNC, 11512A N).

Return loss of the device under test is measured using HP 778D high directivity Directional Coupler as shown in this diagram. High directivity is desirable because it ensures good separation between the incident and the reflected signals, which in turn allows measurement of very small reflection coefficient (high return loss). Since the 778D lower frequency range is limited to 100 MHz, the 8721A directional bridge can be used from 0.5 to 110 MHz.

To make this measurement, the top graticule line is first calibrated for 0 dB return loss with a short. The DUT is then connected to the coupler and terminated in its characteristic impedance.

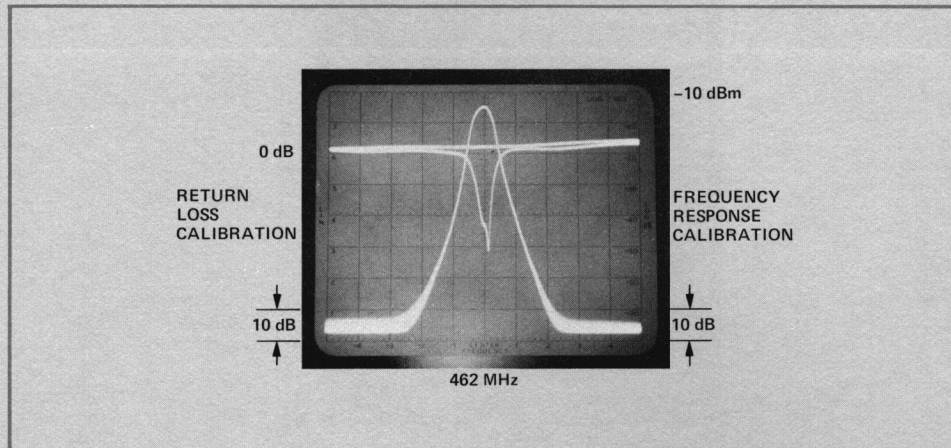
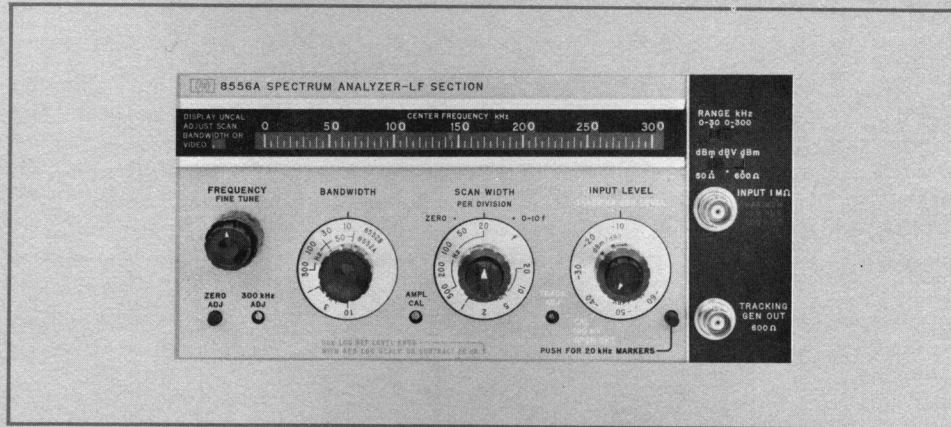

Figure 31. This CRT photograph shows the frequency response and the return loss of a 462 MHz band-pass filter. Within its bandwidth, return loss is greater than 20 dB or a SWR of <1.22 and a $\rho = <0.1$.

CHAPTER 5
THE 8556A ANALYZER TUNING SECTION/TRACKING
GENERATOR
20 Hz - 300 kHz



- Tracking Generator Built-in
- Residual FM <1 Hz
- Tracking Error <±3 Hz
- External Counter Required

I. PRECISE MEASUREMENT OF FREQUENCY

Capabilities:

Frequency Accuracy: ±3 Hz + counter accuracy

Sensitivity: -142 dBm (50 Ω)

-150 dBm (600 Ω)

Selectivity: 10 Hz

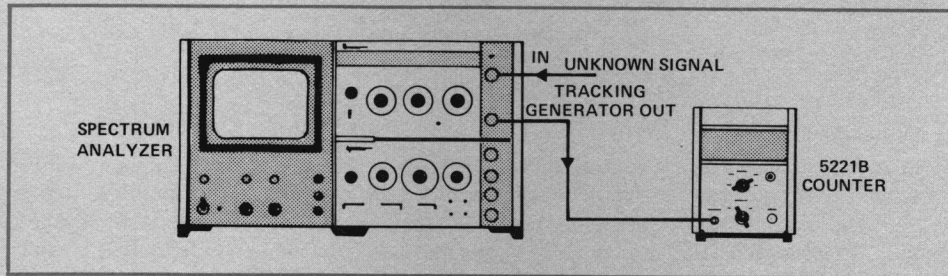

Figure 32. Frequency Counting with the 8556A.

Equipment Needed: 8556A, 8552B,* 141T,** Counter (5300A/5301A or 5221B), shunt and feedthrough accessories.

Both an analyzer tuning section and a tracking generator, the 8556A is rather unique to the Hewlett-Packard spectrum analyzer product line. The analyzer input terminal may be either balanced or unbalanced, and much like an ac voltmeter its input impedance is high. For the unbalanced terminal, input impedance is 1 MΩ shunted by approximately 32 pF; while for the balanced terminal, input impedance is 15 kΩ shunted by approximately 180 pF.

* If an 8552A is used, an external scan ramp with manual scan control is required for frequency counting.
 ** Wherever a 141T is listed in the equipment needed, a 140T or 143S may be used instead; and likewise, an 8552B may be replaced by an 8552A, except as noted.

The tracking generator output is synthesized from a 3 MHz crystal oscillator and the two analyzer local oscillators (see Appendix A for block diagram and theory of operation). Its output impedance is 600Ω , hence a high input impedance counter should be used to count the tracking generator frequency. A 50Ω or other low input impedance counter may load the tracking generator or produce frequency pulling, thus degrading the frequency accuracy.

Counting Procedure

To count the frequency of an unknown signal, a convenient amplitude-calibrated CRT display is obtained. Then the analyzer scan mode is switched to manual and the analyzer is manually scanned to the peak of the signal. The counter display is the desired frequency $\pm 3 \text{ Hz}$ plus the counter accuracy. This accuracy is due to the precision tracking which exists between the 8556A tuning and the tracking generator output frequency.

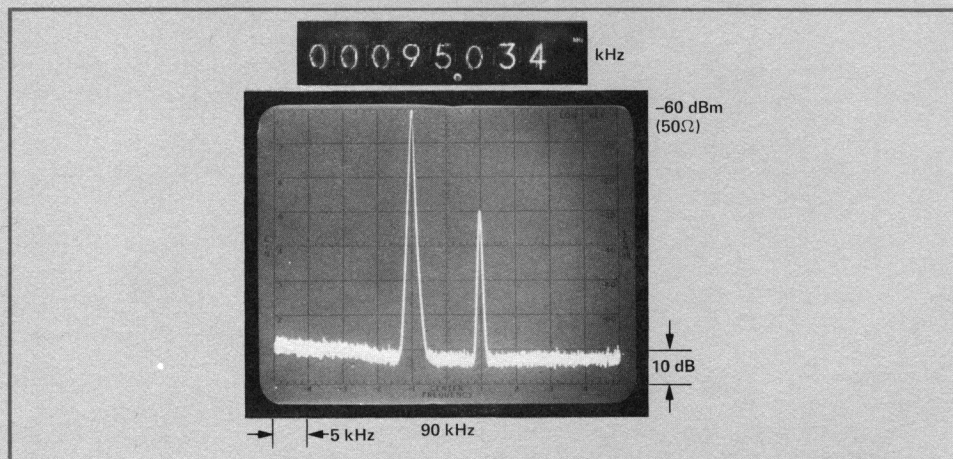

Figure 33. The 8556A can count either one of these two signals. The frequency of the smaller signal was measured by manually scanning the analyzer stopping at the signal peak. Bandwidth is 300 Hz.

Impedance Considerations

A source of error which may exist in this measurement set-up is frequency pulling of the signal/source to be measured. This source of error results if the signal/source is not terminated in its characteristic impedance. Thus, to avoid this error, the signal/source is terminated in its characteristic impedance and the analyzer (which is a high input impedance instrument^o) is connected across the termination. In the 20 Hz to 300 kHz frequency range, several source impedances are encountered, both balanced and unbalanced. 50Ω , 75Ω , and 600Ω are the most common with unbalanced sources; while 135Ω , 150Ω , 600Ω , and 900Ω are the most common with balanced sources. Now, let's look at both types of sources in more detail.

^o 32 pF is approximately $18 \text{ k}\Omega$ at 300 kHz .

A. Unbalanced Sources: (Single Ended Input)

1. 50 Ω and 600 Ω

To prevent frequency pulling, these sources are connected to the analyzer through a feedthrough termination (11048B for 50 Ω and 11095A for 600 Ω), or they can be connected across a transmission line that is externally terminated in its characteristic impedance. This is similar to measurements made with ac voltmeters and allows bridging or terminating measurements. For these sources, the 8556A can measure power in dBm and voltage in both dBV (1 V = 0 dBV) on a log scale and in volts on a linear scale. The feedthrough terminations and the terminated transmission line also satisfy the analyzer requirement; i.e., that the dBm ranges are referenced with the analyzer input properly terminated externally. Voltage measurements are made with the dBm/dBV slide switch set to dBV for a log display or the Log/Linear switch set to linear for a linear display. The voltage displayed will be that developed across the impedance of the termination.

2. Other Impedance Sources

These sources should also be terminated in their characteristic impedances; however, only voltage measurements (log and linear) can be made. This is the case because dBm ranges are only available for 50 Ω and 600 Ω . Again, the voltage displayed on the CRT is that developed across the termination.

B. Balanced Sources

135 Ω , 150 Ω , 600 Ω , and 900 Ω

These sources are connected to the analyzer through a feedthrough termination; i.e., HP part number 1810-0087 for 135 Ω , 1810-0086 for 150 Ω , 1810-0085 for 600 Ω , and 1810-0084 for 900 Ω . These terminations prevent frequency pulling of the sources and provide the external termination needed for the dBm ranges. Thus, power measurements in dBm -135 Ω , dBm -150 Ω , dBm -600 Ω , and dBm -900 Ω can be made. Linear voltage measurements may also be made, and here again the voltage displayed is that developed across the impedance of the termination.

II. SWEEPED FREQUENCY MEASUREMENTS*

Capabilities:

Dynamic Range: >100 dB
Frequency Accuracy: ± 3 Hz + counter accuracy
Scan Width: 200 Hz to 200 kHz

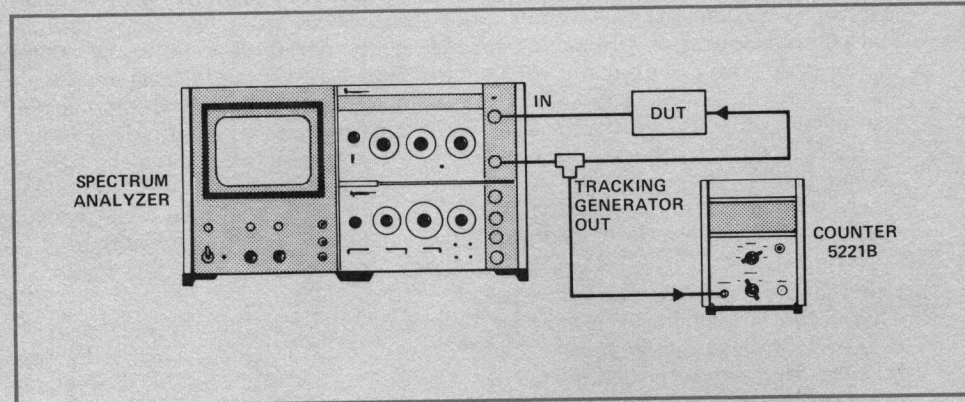

Figure 34. Frequency Response Measurement with the 8556A.

Equipment Needed: 8556A, 8552B, 141T, Precision Attenuator (4437A/4436A optional), Counter (5300A/5301A or 5221B), shunt and feedthrough accessories.

In this configuration, the tracking generator output is split by a BNC Tee; one half is connected to a high input impedance counter and the other half is connected to the device under test (DUT).

To eliminate the sources of error in this measurement, the input and output impedances of the DUT must be matched. In addition, the tracking generator output should be calibrated to a convenient reference level on the CRT so that the DUT insertion loss can be directly read off the display. Since these problems are discussed in detail under Impedance Matching and Calibration below, we will assume for the moment once again that the sources of error have been eliminated and the frequency response of the DUT is displayed on the CRT. So now we can look for display calibration, dynamic range, counting, and any other pertinent considerations.

To calibrate the display, set up the scan width and IF bandwidth and gradually increase scan time until the display amplitude remains constant with changes in scan time. At that point, the display is calibrated and the scan rate satisfies the bandwidth requirement of both the analyzer and the device under test. Repeat this procedure if either the scan width or IF bandwidth are to be changed.

Larger than 100 dB dynamic range can be obtained by reducing the IF bandwidth (since this reduces the noise level of the analyzer) and/or increasing the signal level. Maximum dynamic range (>150 dB) can be obtained with the 10 Hz IF bandwidth and a signal level of +10 dBV.

Precision insertion loss measurements can be made in 600 Ω systems with the 8556A using either the 4437A (unbalanced) or the 4436A (balanced) attenuators. In addition, precision calibration lines can be established for 3 dB points, 6 dB, 60 dB, etc.

Counting the frequency of any point on the CRT is easy. Switch the analyzer Scan Mode to Manual and manually scan to the point of interest. Since precision tracking exists between the analyzer tuning and the tracking generator output, the counter display is the frequency of the unknown signal.

* Closed-loop applications of the 8556A are limited to frequency response and insertion loss measurements. Reflection measurements are not done.

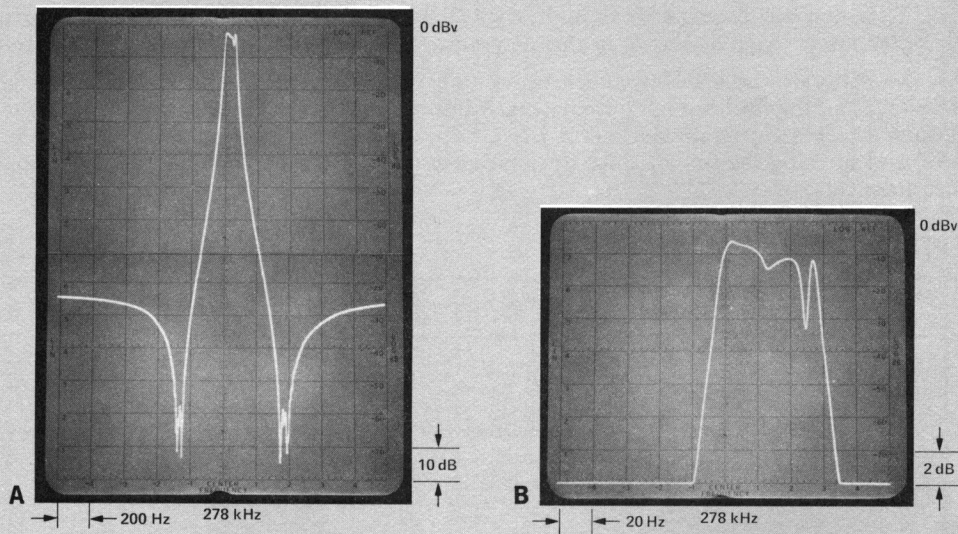

Figure 35.

A. This CRT photograph shows the frequency response of a 278 kHz bandpass filter over a range greater than 135 dB. Two photographs were stacked vertically; one photograph was taken at 0 dBV and the other at -70 dBV.

B. Passband details.

Impedance Matching and Calibration

The input and output impedances of the DUT should be matched to produce an accurate frequency response display. If not properly matched, the RC time-constant of the DUT may change, this may distort the frequency response and may cause the device to have a higher insertion loss because of poor power transfer. Furthermore, to read the insertion loss of the DUT directly off the display, the tracking generator output should be calibrated to a reference level on the CRT.

The unbalanced input analyzer measures power in dBm for 50 Ω and 600 Ω devices only, and it measures voltage in dBV and linear volts for 50 Ω and 600 Ω , as well as other impedance devices. The balanced input analyzer measures power in dBm for 135 Ω , 150 Ω , 600 Ω , and 900 Ω , and it measures voltage on a linear scale for the same impedances as well as others. Several examples showing how to match the DUT and calibrate the tracking generator output are shown below.

1. 50 Ω Input/Output Device

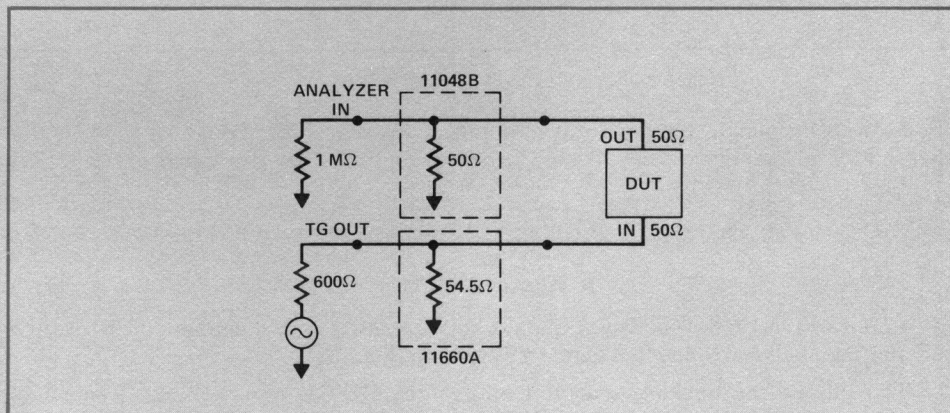

Figure 36. 50 Ω Input/Output Device.

To match this device at both ends, a 50 Ω shunt (11660A) and a 50 Ω feedthrough (11048B) are inserted as shown in this diagram.

To calibrate the tracking generator output, remove the device under test leaving the shunt and the feedthrough termination. Adjust the tracking generator output to bring the trace to the top graticule line of the CRT, thus providing a convenient reference level and utilizing the full CRT for dynamic range. The DUT can now be reinserted for measurement.

2. 600 Ω Input/Output Device

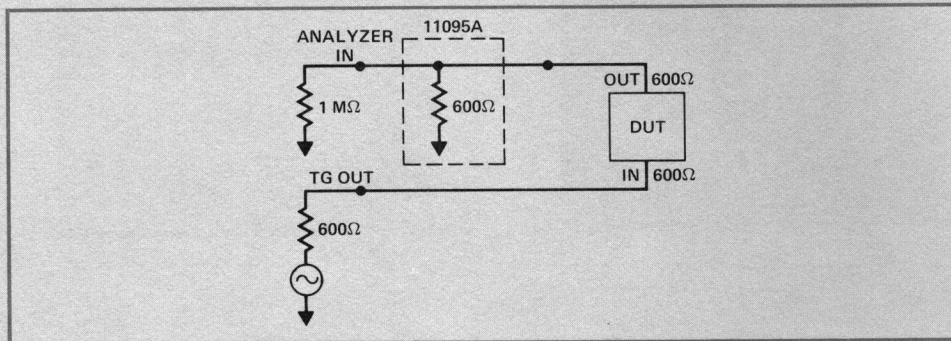

Figure 37. 600 Ω Input/Output Device.

Since the tracking generator output is 600 Ω , this device is connected directly to the tracking generator. However, a 600 Ω feedthrough termination (11095A) is inserted between the output of the device and analyzer input as shown in Figure 37.

To calibrate the tracking generator output, remove the device under test (leaving the feedthrough in) and adjust the tracking generator output to bring the trace to the top graticule line of the CRT.

3. 75 Ω Input, 135 Ω Output Device

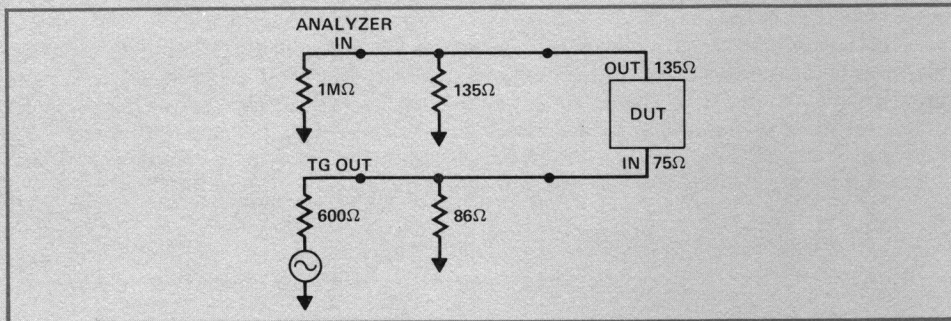

Figure 38. 75 Ω /135 Ω Input/Output Device.

In order to match this device at its input, a shunt resistor should be used so that when added in parallel to the tracking generator output, they are equal to 75 Ω , i.e.,

$$75 = \frac{600 \times R_{\text{shunt}}}{600 + R_{\text{shunt}}}$$

or

$$R_{\text{shunt}} \cong 86 \Omega.$$

The output of this device, however, should be terminated with a simple 135 Ω resistive load and the analyzer connected across this termination.

To calibrate the tracking generator output, the DUT is removed, and a matching attenuator of known insertion loss and 75 Ω input 135 Ω output impedance is inserted instead. The 86 Ω shunt and the 135 Ω termination still show the attenuator matched at

both terminals. Now, adjust the tracking generator output to bring the trace to the top graticule of the CRT. Remove the attenuator and increase the log reference level and/or the vernier by the value of the attenuator. Thus, the tracking generator output is calibrated for this device and by inserting the device back in the set-up, we can see its insertion loss directly on the CRT; i.e., the number of dB down from the top graticule line.

4. 900 Ω Input, 1 M Ω Output Device

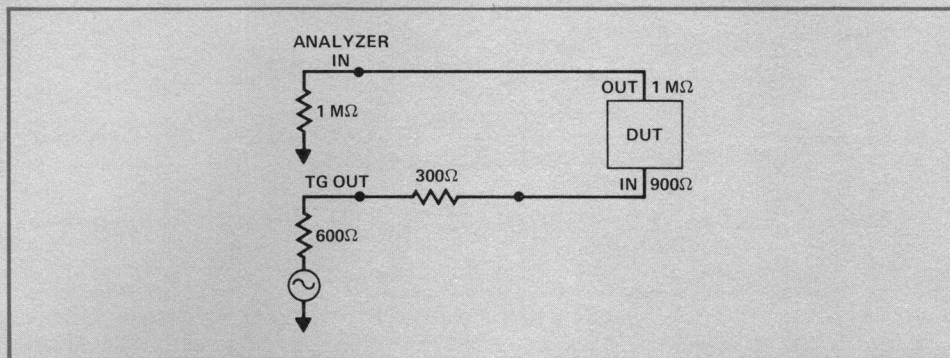

Figure 39. 900 Ω /1 M Ω Input/Output Device.

To match this device, we only need to add a 300 Ω resistor in series with the tracking generator 600 Ω output impedance. Since the device output impedance is high, the output terminal is directly connected to the analyzer. The tracking generator output is calibrated with a matching attenuator (900 Ω , 1 M Ω) of known attenuator value, as described in Example 3 above.

5. Balanced Input Devices, 135 Ω , 600 Ω , or 900 Ω

These devices have also to be matched at both the input and output terminals. Thus, the output terminal requires a matching termination of 135 Ω , 600 Ω , or 900 Ω . The input terminal, however, is matched differently since the tracking generator impedance has to be considered. For 135 Ω devices, a shunt resistor approximately 178 Ω is used (178 Ω in parallel with 600 Ω). 600 Ω devices are already matched; their input is connected directly to the tracking generator output. 900 Ω devices are matched as in Example 4; i.e., a 300 Ω series resistor is connected to the tracking generator output.

The tracking generator output is calibrated as in the above examples. For 600 Ω devices, a Hewlett-Packard precision attenuator, the 4436A, can be readily used. 135 Ω and 900 Ω can be adapted for use with this attenuator, if a matching attenuator isn't available.

6. Measuring Amplifier Gain

In addition to matching the input and output impedances of the amplifier, the amplifier saturation level should be considered. The tracking generator output level should be reduced so that the amplifier is below saturation. If the output level is reduced to 100 mV and the amplifier is still saturated, then an external attenuator should be used. The 600 Ω feedthrough, the 50 Ω shunt, series or parallel resistors can be used as external attenuators; however, the choice of attenuator requires re-examining matching the input of the amplifier and making any adjustments if necessary. If on the other hand the amplifier is high gain and its output is more than +10 dBV (the maximum signal level in the analyzer), then an external attenuator of known insertion loss should be used before connecting to the analyzer. Here again, the attenuator should be considered in matching the output port of the amplifier.

CHAPTER 6
SPECIAL APPLICATIONS

RECEIVER RESPONSE

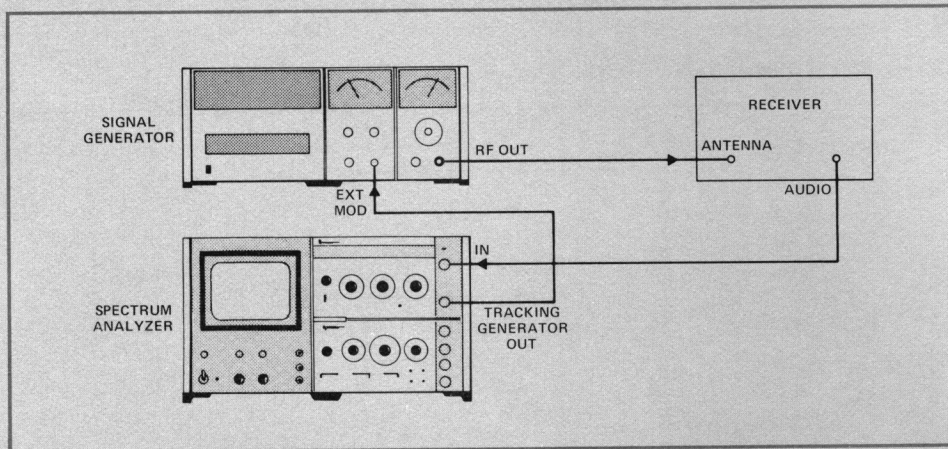

Figure 40. Receiver Response Measurement.

Equipment Needed: 8556A, 8552B, 141T, Signal Generator.

Using the set-up shown in Figure 40, the overall frequency response of the receiver can be displayed on the CRT. A quick analysis of this test shows that the tracking generator output is used to externally modulate the signal generator. The modulated RF output is connected to the antenna of the receiver, the receiver demodulates the signal and the demodulated output (audio output) is connected to the analyzer input.

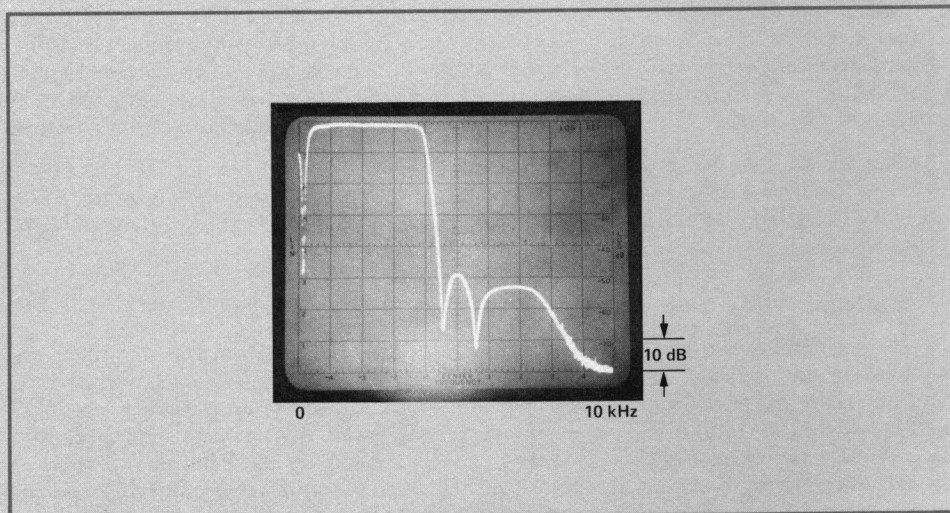

Figure 41. This CRT photograph shows the overall response of a high performance receiver. Notice how response drops sharply beyond 4 kHz.

LOOP GAIN

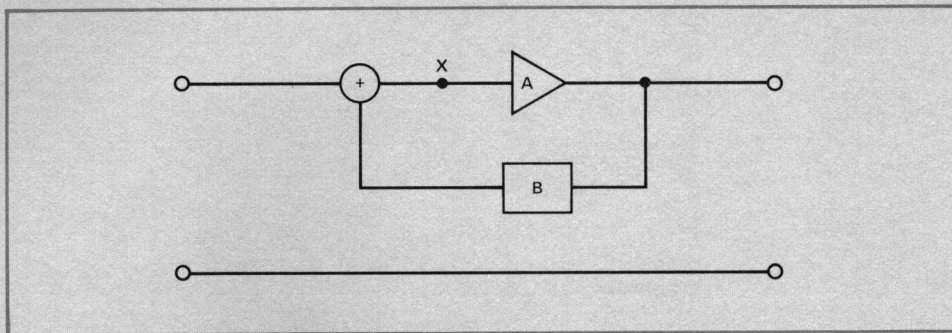

Figure 42. Simplified Feedback Block Diagram.

Equipment Needed: 8556A, 8553B, 8552B, 141T, AC Current Probe (1110A).

Figure 42 is a simplified block diagram for a standard feedback circuit. From this diagram, we can see that the feedback loop gain is equal to AB . Figure 43 is an equivalent circuit of the same feedback circuit when the loop is broken at point X.

If $Z_{out} \ll Z_{in}$, connect the tracking generator output through the 1110A current probe and clip the probe around a lead in the feedback circuit where the signal is confined to a single path, as shown in Figure 43. Loop gain (AB) for this circuit is

$$AB = \frac{E_{out}}{E_{in}}$$

Measure E_{out} on the CRT and set it as reference at a convenient location; i.e., upper half of the CRT or the top graticule line. With the variable persistence, store E_{out} display. Now measure E_{in} and store it. Loop gain at each point on the frequency spectrum is the difference between E_{out} and E_{in} .

If $Z_{in} \ll Z_{out}$, connect the tracking generator output through a series resistor R ($R \gg Z_{in}$) to a point in the feedback circuit where the signal is again confined to a single path as shown in Figure 45.

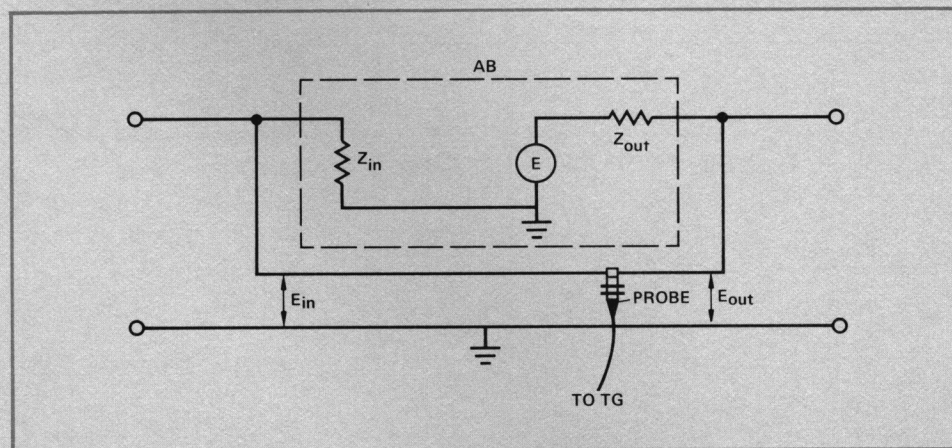

Figure 43. Equivalent Circuit of Feedback Loop Shown in Figure 42 ($Z_{out} \ll Z_{in}$).

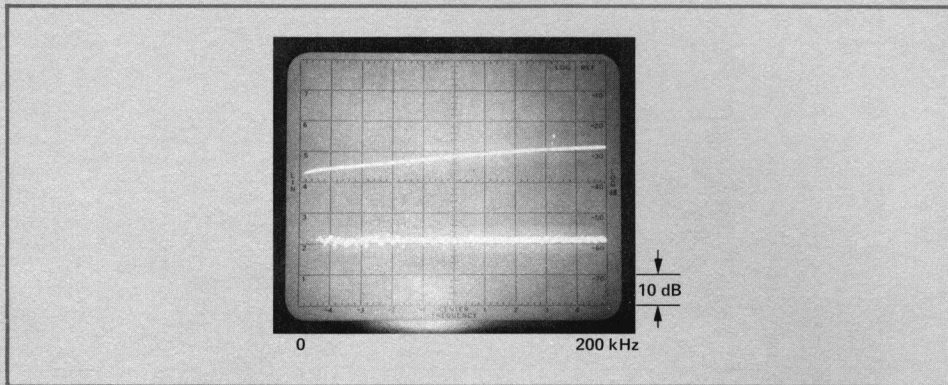

Figure 44. This CRT photograph shows the loop gain of a high quality FM tuner. Loop gain for this tuner varies from 21 dB at low frequency to 30 dB around 200 kHz.

From this diagram, loop gain AB is

$$AB = \frac{I_2}{I_1}$$

Thus, to measure loop gain, connect the 1110A current probe to I_2 , set it as reference, and store. Measure I_1 and store. Loop gain is the difference between I_2 and I_1 .

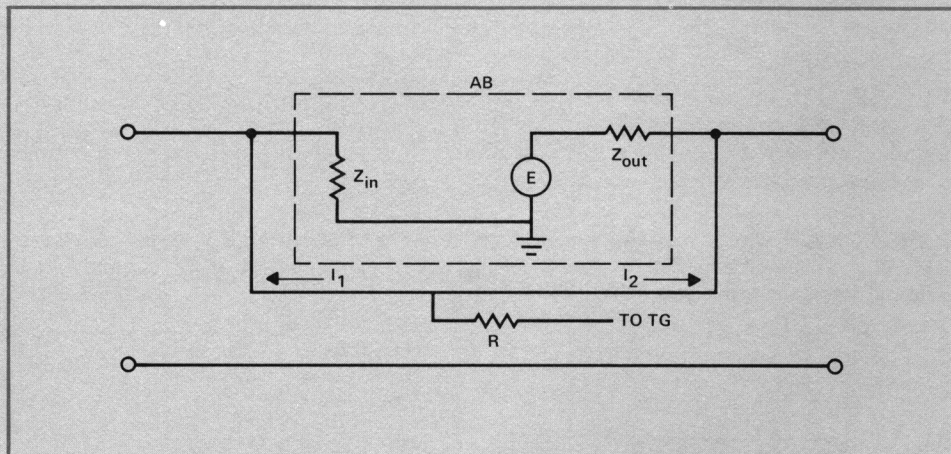

Figure 45. Current Source Simulation When $Z_{out} \gg Z_{in}$.

**BEAT FREQUENCY TECHNIQUE:
Improved (open-loop) 8444A Counting Accuracy**

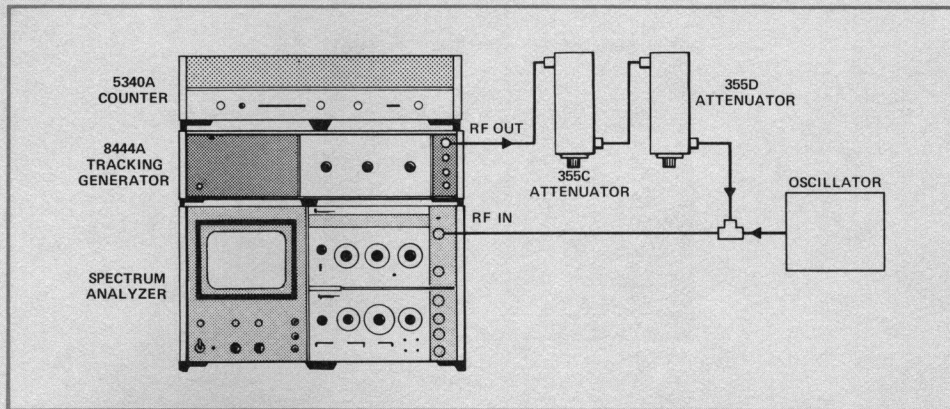

Figure 46. 8444A Improved Accuracy Configuration.

Equipment Needed: 8444A, 8554L or 8555A, 8552B, 141T, Attenuators (355C and 355D), Counter (5340A or 5248L or M with 5254C).

The object of this technique is to improve the frequency counting accuracy of the 8444A in the open-loop mode. Standard open-loop accuracy as indicated in Chapter 4 is ± 10 kHz. With this technique, accuracy is improved to ± 200 Hz; the improvement essentially cancels out the tracking error.

Procedure

Separately display and center the unknown signal on the CRT using 10 kHz or 3 kHz bandwidth and the blue-coded portion of the scan width control. Note the power level of the signal in dBm. Set the tracking generator output to 0 dBm and adjust the 355C and 355D so that the tracking generator output level at the analyzer input is equal to that of the unknown signal. Mix the unknown signal and the tracking generator output using a BNC tee or a directional coupler (if source isolation is necessary) as shown in Figure 46. The CRT display will appear as shown in Figure 47.

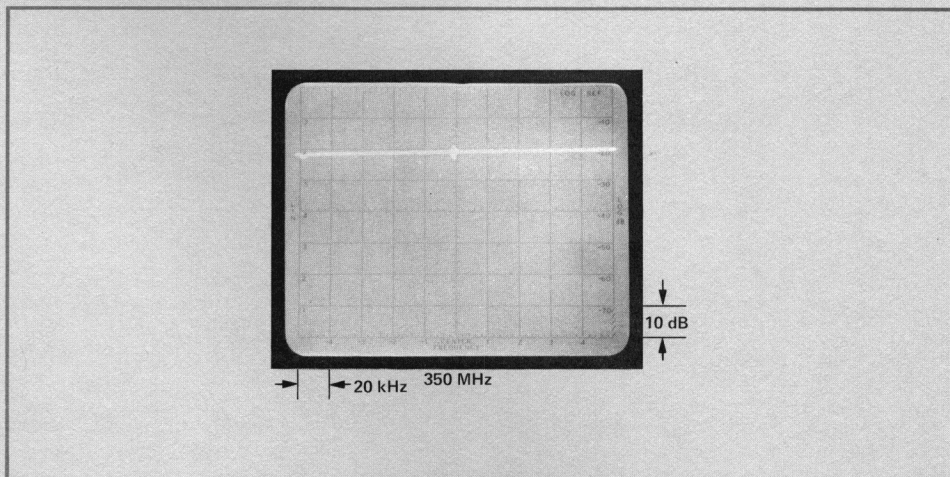

Figure 47. Beat Signal.

Since the analyzer is in scan width per division, the 8444A output is ΔF swept signal centered about the frequency of the unknown signal. This output appears as a horizontal line on the CRT. However, at the point where the tracking generator frequency is equal to the unknown frequency, a beat develops as shown above.

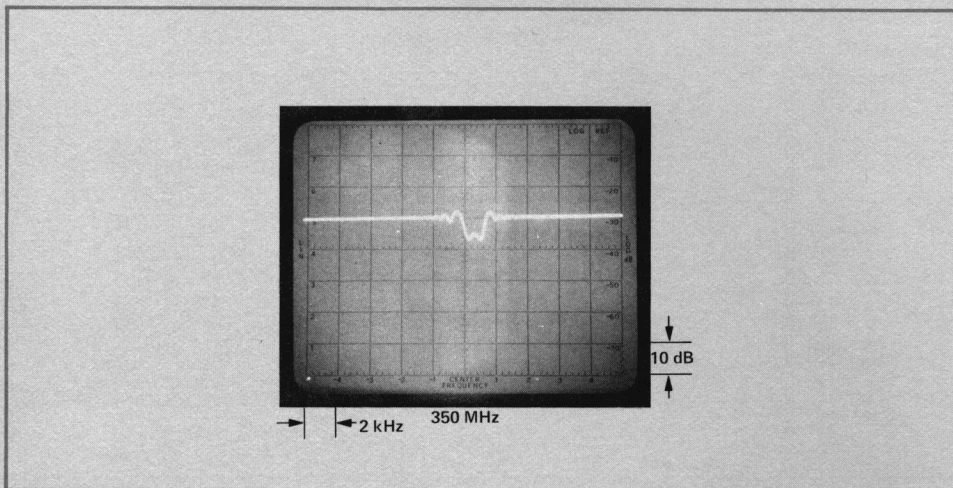

Figure 48. Beat Signal Expanded.

Expand the CRT display using 1 kHz bandwidth and 2 kHz/division scan width, if possible. The CRT now appears as in Figure 48. Notice how sharp the beat is. For ease and simplicity of measurement, adjust tracking of the 8444A for maximum and center the beat frequency on the CRT. Now switch the analyzer scan mode to External and with the 8444A Manual Scan control, scan the analyzer until a bright spot will dance up and down the CRT. At that point the tracking generator output frequency is equal to the unknown signal frequency. The counter display is the frequency of the unknown signal, ± 200 Hz.

PROBING TECHNIQUES WITH THE SPECTRUM ANALYZER/TRACKING GENERATOR

The HP 1121A High Impedance AC Probe

The 1121A is used to make direct measurements on in-system sensitive circuits without disturbing the circuits' performance.* The broad frequency range, 1 kHz to more than 500 MHz, makes it possible to use the 1121A with both the 8553B/8443A and B and the 8554B/8444A. The probe is directly operated from the front panel of the 8553B, but it requires an HP 1122A probe power supply when used with the 8554B.

Zero dB Insertion Loss Calibration

A typical measurement situation is shown in Figure 49. A simple passive divider probe injects the tracking generator signal at the input of the circuit under test and the 1121A ac active probe is connected across the output. To establish the zero dB insertion loss reference level, the two probes are applied across a 50 Ω transmission line properly terminated as shown in Figure 50. For convenience this level is placed at the top graticule line of the CRT.

The 1121A gain is flat enough to preserve the absolute amplitude calibration of the spectrum analyzer. It can also be used in front of the 8447A (0.1 - 400 MHz, 20 dB gain amplifier) and effectively have a high impedance probe with 20 dB gain. Capacitive loading caused by the 1121A is very negligible since its shunt capacitance is <3 pF. However, <1 pF can be obtained with two 10:1 divider accessories available, the 10241A and the 10243A.

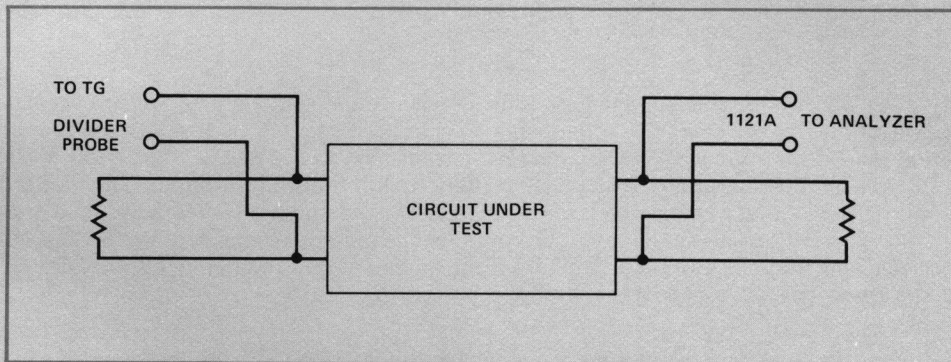

Figure 49. Probing with the Spectrum Analyzer.

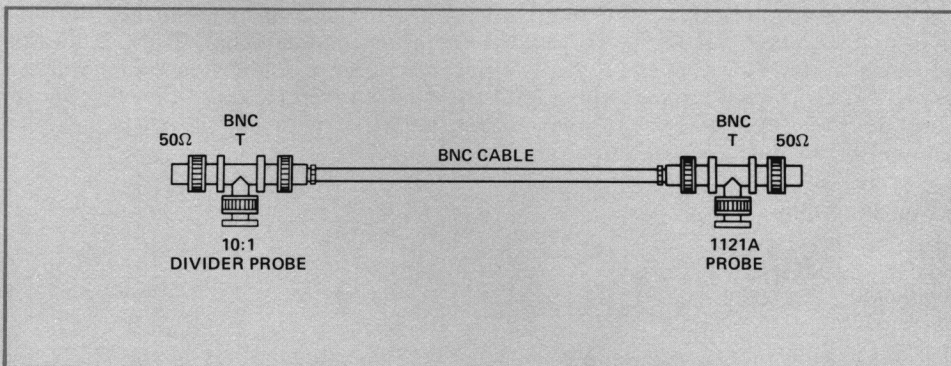

Figure 50. 0 dB Probe Calibration.

* This measurement procedure can be used for circuits with input/output impedances of 100 k Ω or less. With a 10:1 divider, the 1121A will look like 1 M Ω and should not change the circuit performance.

AUTOMATIC SPECTRUM SURVEILLANCE

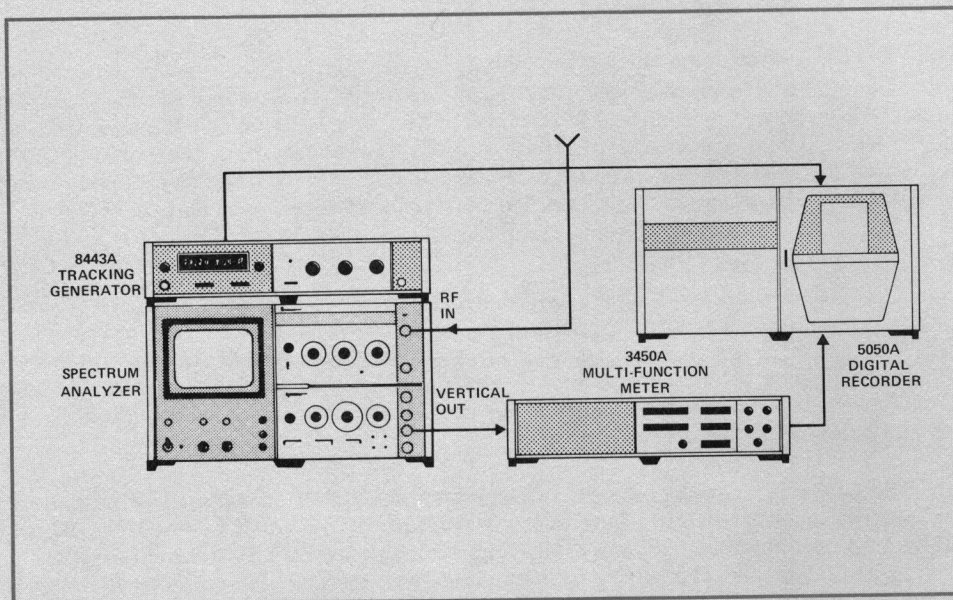

Figure 51. Automatic Spectrum Surveillance Configuration.

Equipment Needed: 8443A, 8553B, 8552B, 141T, Digital Voltmeter (3450A Opt. 003/004), Digital Recorder (5050B Opt. 001/055), Amplifier (8447A), Whip Antenna.

The purpose of this surveillance is to detect, count, and digitally record signals appearing in the 0.1 - 100 MHz frequency spectrum. Figure 51 is a relatively simple set-up that can do this job. A whip antenna is connected to the 8447A, 0.01 - 400 MHz amplifier, and the output of the amplifier is connected to the analyzer input. The vertical output of the analyzer is connected to the 3450A digital voltmeter (DVM) with limit test option. The 3450A digital output and print command are connected to the 5050B recorder with the clock option. Digital output of the 8443A counter is also connected to the recorder.

Now, let's see how this system operates. A full 8-division CRT response corresponds to -0.8 volt at the vertical output; or -0.1 volt/division. The 3450A limit test and digital output options are wired to issue a print command for a selectable dc level. Upon receipt of this command, the 5050B recorder prints the data at its input; i.e., the time of day, the vertical voltage level, and the frequency of the signal. Thus, if the log reference level is -30 dBm and if the 3450A is set to issue a print command for voltages below -0.4 volt, then a signal whose level is -60 dBm (vertical output -0.5 volt) will cause the DVM to issue a print command. But a -80 dBm signal will not be recorded because the analyzer vertical output level is -0.3 volt.

Set-up Procedure

Scanning: Per Division
Tuning: 50 MHz, 10 MHz/div
Bandwidth: 300 kHz

Since we can change the log reference level (top graticule line of the CRT), the number of vertical divisions a signal occupies can be changed, and correspondingly the voltage at the vertical output will change. This allows us to select the level of the signal in dBm above which surveillance should be recorded. Furthermore, since the DVM measures peak levels, the lowest signal to be measured should be at least 10 dB above the average noise level. For 300 kHz IF bandwidth, average noise level is -95 dBm and the lowest measurable signal is -85 dBm.

To record signals above this level, the 3450A is first set to issue print commands for voltage levels below a convenient level, such as -0.4 volt; i.e., for signals whose amplitude occupies four vertical CRT divisions or more. Now, by setting the log reference level at -45 dBm, the center of the CRT (which corresponds to -0.4 volt) is -85 dBm. Thus, a -85 dBm signal causes the DVM to issue a print command and the same is true for higher signal levels.

Since continuous surveillance is desired, the 8443A is switched to Scan Hold and the Marker Position knob is turned fully clockwise until the Marker disappears at the edge of the CRT. In this position, the counter counts continually from 0 to 100 MHz and repeats. Frequency resolution must now be considered. The limiting factor in this set-up is the 3450A, since its fastest measuring time is 65 ms. With 1 sec/division scan time, frequency resolution is calculated as follows:

$$\frac{1}{65 \times 10^3} = 15 \text{ counts per division can be made}$$

Since we are scanning 10 MHz per division, we can count a signal every 650 kHz; i.e., $10 \times 10^6 \div 15$. Therefore, resolution is 1 MHz. Using similar calculations with 10 sec per division scan time, we see that we can count a signal every 65 kHz. This is the best resolution obtainable; however, the bandwidth must be reduced to 30 kHz.

The 5050B has a capacity to print 18 columns. Seven columns or less for time (0.1 second resolution), three columns for dc voltage level (1 mV resolution) and six columns for frequency (the last two or three insignificant, depending on scan time).

TRACKING GENERATOR TO 18 GHz
(Swept Insertion Loss and Return Loss Measurements Only)

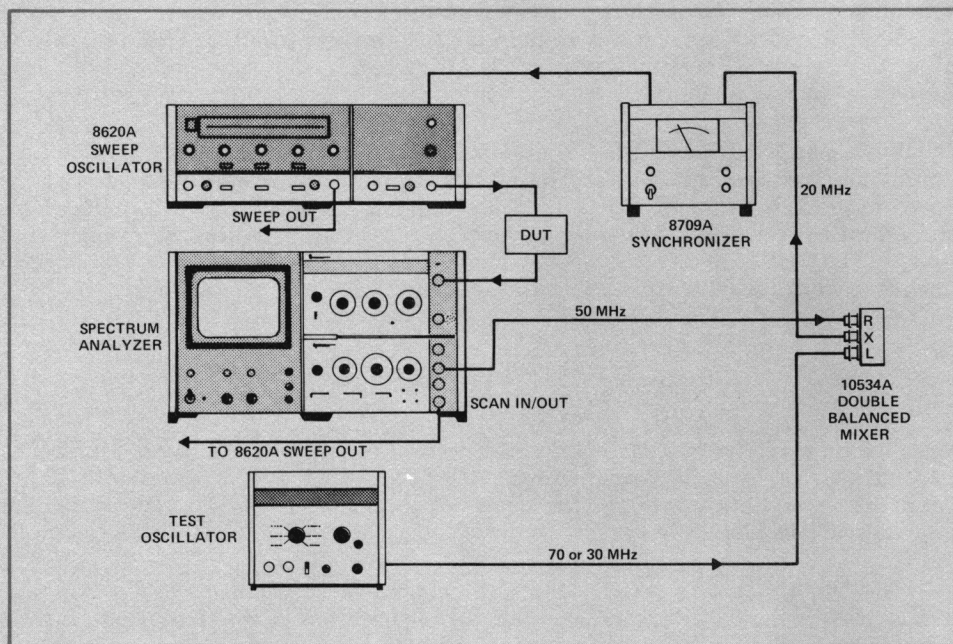

Figure 52. Tracking Generator Configuration to 18 GHz.

Equipment Needed: 8555A, 8552B Opt. H07 and H12, 141T, HP Sweeper 8620A or B and RF plug-ins or 8690B Opt. H61 and RF plug-ins,* HP Synchronizer 8709A, Test Oscillator or Signal Generator (3200B, 8660A/86601A or 8640A/B), Double Balanced Mixer (10534A).

A tracking generator up to 18 GHz can be obtained using the configuration shown in Figure 52. Maximum frequency width displayed on the CRT is 2 GHz and dynamic range is typically 45 dB. Essentially, tracking between the 8555A tuning and the 8620A output signal occurs because a phase comparator in the 8709A phase locks the 8620A to the analyzer 50 MHz IF. As we can see from this configuration, the 8620A output signal is connected to the 8555A input. The 8555A 50 MHz IF is mixed in the 10534A (double balanced mixer) with a signal from the test oscillator to produce a 20 MHz IF. This 20 MHz is connected to the 8709A where the phase comparator compares it with an internal 20 MHz LO and produces a dc voltage which is then applied to the 8620A phase lock input.

Tracking Procedure

The tracking procedure has been divided into sequential steps to ensure fast set-up time and accurate tracking.

A. Initial Set-Up

Disconnect the output of the 8709A from the phase lock input of the 8620A.

8620A

CW Mode: Tune to the center frequency of the frequency range of interest; for example, if 8 - 10 GHz is of interest, tune to 9 GHz.

Power Output:** 0 dBm

* 8690B plug-ins should have H15 or H81 modification.

** Other power levels can be used, but the combination of 8620A power level and 8555A attenuator should be such that power into the 8555A input mixer is -10 dBm, the gain compression level.

8555A

Frequency Band: Select band which best covers the frequency range of interest.
Note mixing mode.
Scan Width: Per Division
Attenuation: 10 dB
Scan Mode: Internal

Test Oscillator

Frequency: Tune to 70 MHz for the 8555A "n—" mixing mode and to 30 MHz for "n+" mixing mode.

Display the 8620A CW signal on the CRT using the signal identifier to make sure that the 8555A is properly tuned. This must be done before proceeding any further. Note the signal power level.

B. Phase Lock

1. Center the 8620A signal in the middle of the CRT, switch the analyzer scan width to zero, IF bandwidth 300 kHz, and scan mode to *External*.
2. Connect the 8709A output to the phase lock input of the 8620A. Look for phase lock indication. The 8709A "unlocked" light is OFF when phase lock occurs.
3. Fine tune either the 8620A or the 8555A until the "unlocked" light is turned OFF. A dot should now appear on the CRT and the power level of this dot should be at approximately the same level as that of the CW signal just measured.

C. Tracking

1. With the 8555A set to 300 kHz or 100 kHz IF bandwidth, fine tune the test oscillator for a maximum level of the dot.
2. Reduce the IF bandwidth to 3 kHz or 1 kHz and repeat tuning. The position of the dot is very sensitive now and only minor tuning should be required. Return the IF bandwidth to 300 kHz after tuning is done.
3. Switch the 8555A to per Division Scanning. Adjust scan width so that it covers or exceeds* the frequency range of interest.
4. Switch the 8620A to START/STOP Sweep and SWEEP MODE to MANUAL. Tune the START/STOP frequencies to correspond to the low/high ends of the scan width just established in C-3 above.
5. With the 8620A Manual Sweep Control fully counterclockwise, minor adjust the START control until lock is achieved.
6. Turn the Manual Sweep Control fully clockwise and again minor adjust the STOP frequency until lock is achieved. Observe the level of the dot at both START/STOP ends; this level should be approximately equal to the level measured in B-3 above.
7. Switch the 8620A to AUTO sweep and adjust sweep time for a convenient CRT display. At this point, tracking exists between the 8620A and the 8555A tuning for the specific frequency settings.

* It may be necessary to exceed frequency range of interest because the analyzer scan width is in fixed increments.

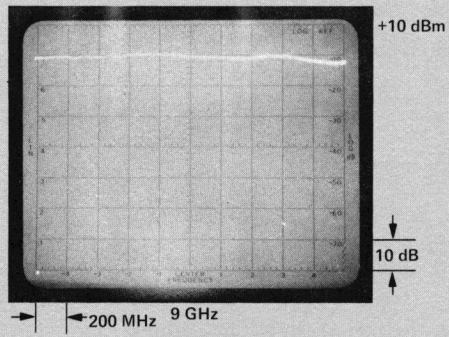

Figure 53. Tracking Generator Output.

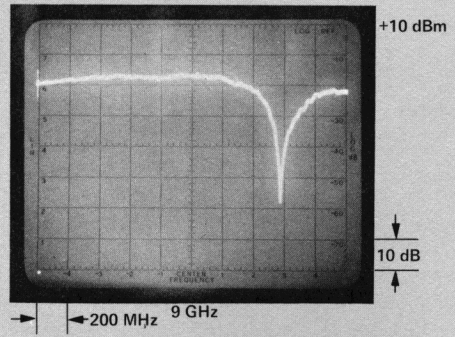

Figure 54. Frequency Response of a Microwave Cavity.

APPENDIX A

8443A

A simplified block diagram is shown for the 8553B/8552()/140 Series/8443A spectrum analyzer/tracking generator. The 8443A has two functions, "Track Analyzer" and "Restore Signal." In the "Track Analyzer" function, the 8443A resembles the 8444A and 8556A in that it provides an output signal which precisely tracks the analyzer tuning. In the "Restore Signal" function, the 8443A simply produces an output signal which is identical in frequency to the signal at the analyzer input.

"Track Analyzer" Function

To generate a signal at the tuned frequency of the analyzer, the 8443A recombines all three LO's with its own 3 MHz crystal oscillator. Crystals in this oscillator and the analyzer's 3 MHz IF filter are the same type. This ensures frequency tracking with temperature variations and aging. In addition, a front-panel adjustment permits pulling the crystal oscillator ± 150 Hz from center frequency to compensate for any slight differences between the IF filter and oscillator frequencies.

To prevent spurious mixing products from entering the output, the IF amplifiers and filter used in the 8443A are the same as those used in the spectrum analyzer. With voltage-variable gain, the 200 MHz IF amplifier delivers the necessary modulation for leveling the output signal. The 120 MHz low-pass filter that follows the third mixer blocks the LO signal and undesired upper-sideband mixing products.

Two hybrid microcircuits, a preamplifier and a power amplifier, follow the low-pass filter. The power amplifier includes a peak detector for an automatic level control (ALC) which feeds back a control signal to the variable-gain 200 MHz IF amplifier. Two precision attenuators that follow the power amplifier provide an adjustable output level (120 dB range in 1 and 10 dB steps to +10 dBm max.). In the ALC loop, a vernier calibrated to 0.1 dB allows 1.2 dB variation in output level.

The 8443A output is a high-level, tracking signal that coincides with the tuning of the spectrum analyzer. To count the tracking signal's frequency, we stop the sweep of the spectrum analyzer (thus, the sweep of the 8443A) at some predetermined point. Then we momentarily open the counter gate to make a frequency measurement before resuming the sweep. This pause in the sweep puts an intensified marker on the CRT which identifies where the counter reading was taken. From a front panel control the operator can place the marker on any signal or anywhere along a swept-frequency response displayed on the CRT.

"RESTORE SIGNAL" FUNCTION

In the "Restore Signal" function, the 8443A 3 MHz crystal oscillator is turned off (crystal bias changed to turn off oscillation) and is replaced by the 3 MHz IF signal from the analyzer final IF stage. This is the only circuit change made, but as we have noted, the tracking generator has an entirely different output. The output level in this function depends on the level of the unknown signal at the analyzer input as well as the precision attenuators in the 8443A.

To count the frequency of the unknown signal, the marker is placed anywhere on the signal, typically 15 dB above the noise level. This is the minimum signal-to-noise ratio at which the counter will be triggered. The "Restore Signal" function makes it easier to measure the frequency of signals displayed on the CRT since it is no longer necessary to go to very narrow scanning to place the marker in the middle of the signal.

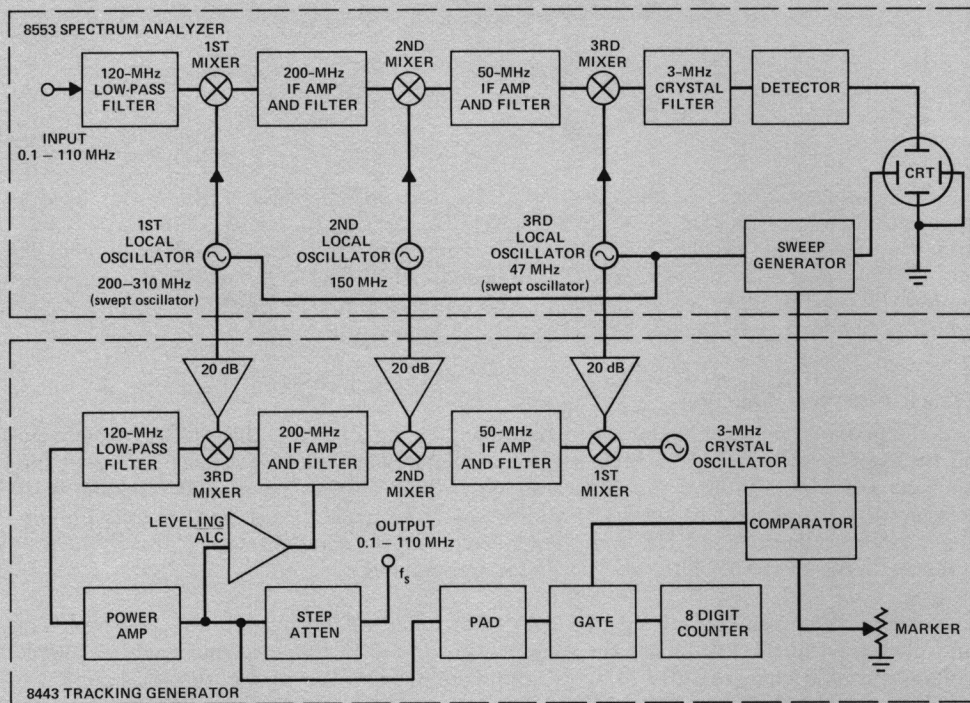

Figure 55. 8443A/8553B System Block Diagram.

8443B

The 8443B duplicates the tracking generator section of the 8443A except for the "Restore Signal" function. All information contained in the previous pages and pertaining to tracking also applies to the 8443B.

8444A

The 8444A Tracking Generator is used with either the 8554B/8552()/140 Series or the 8555A/8552()/140 Series spectrum analyzers. When used with the 8554B RF section, the tracking generator covers the 0.5 - 1250 MHz range, and when used with the 8555A RF section, the tracking generator covers the 10 MHz to 1300 MHz range on the $n = 1 - (2.05 \text{ GHz IF})$ band.

Two simplified block diagrams are shown for the 8444A: Figure 56 is with the 8554B and Figure 57 is with the 8555A. In both diagrams the first and third local oscillators in the spectrum analyzer are applied to the tracking generator where they are combined with the output of the 1.55 GHz cavity oscillator. The 1.55 GHz frequency of this cavity oscillator is equal to the sum of the 1.5 GHz second LO, the 47 MHz fourth LO, and the 3 MHz IF signal. This cavity oscillator is voltage-tunable by the front panel TRACK ADJ control; this tuning compensates for minor frequency variations of the analyzer second and fourth local oscillators which are not synthesized in the 8444A.

The first LO input is applied through isolators and a 2.0 - 3.4 GHz bandpass filter to the second converter. The third LO input is applied through a 500 MHz limiter amplifier and PIN diode modulators to the first converter. The 500 MHz third LO signal is combined with the output from the 1.55 GHz cavity oscillator. The output from the first converter has a center frequency of 2.05 GHz with a tuning range of ± 2 MHz plus the deviation of the 500 MHz signal from the analyzer. The 2.05 GHz first converter output is mixed with the 2.05-3.4 GHz (2.05-3.3 GHz for the 8554B) output from the bandpass filter in the second converter. The second converter output is applied through the 0 - 1.3 GHz low-pass filter, amplifier, and ALC circuitry. The resultant output is a signal in the frequency range of 0 - 1.3 GHz. The frequency of this signal precisely tracks the tuning frequency of the spectrum analyzer.

The power level of the tracking generator RF output is controlled by an ALC circuit. The ALC detector is part of a large-scale integrated (LSI) circuit package containing an attenuator, low-pass filter, output amplifier, and a dc blocking capacitor. The detected signal is applied through a dc amplifier to PIN diode modulators in the third LO signal path to the tracking generator first converter. The RF output level is adjustable over the 0 to -10 dBm range by a front panel LEVEL control in the dc amplifier circuit. The LEVEL control is calibrated at 0 dBm.

Sweep and tune control of the spectrum analyzer from the tracking generator is provided by a 0 to +10 volt signal controlled by a front panel MANUAL SCAN control.

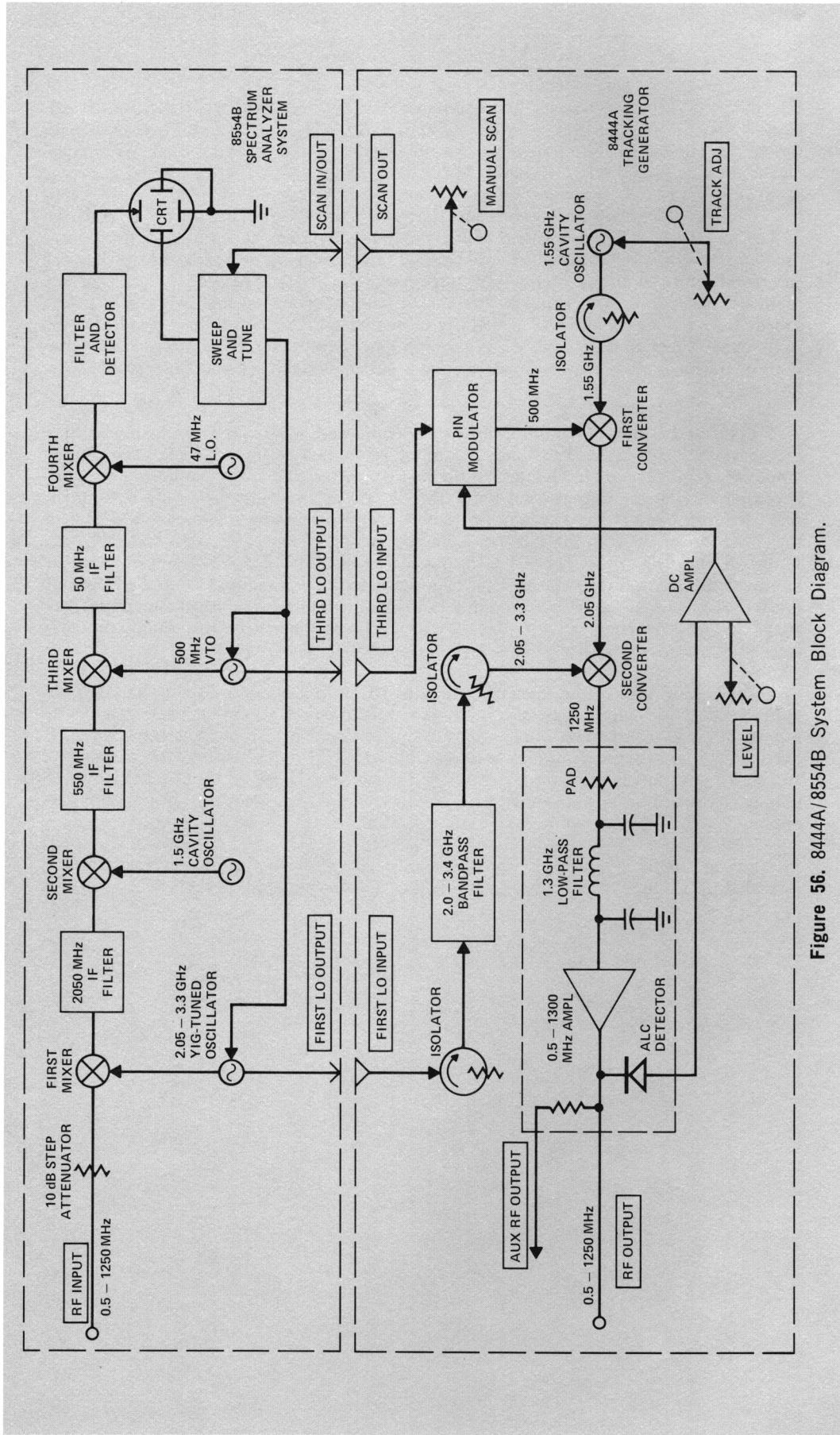

Figure 56. 8444A/8554B System Block Diagram.

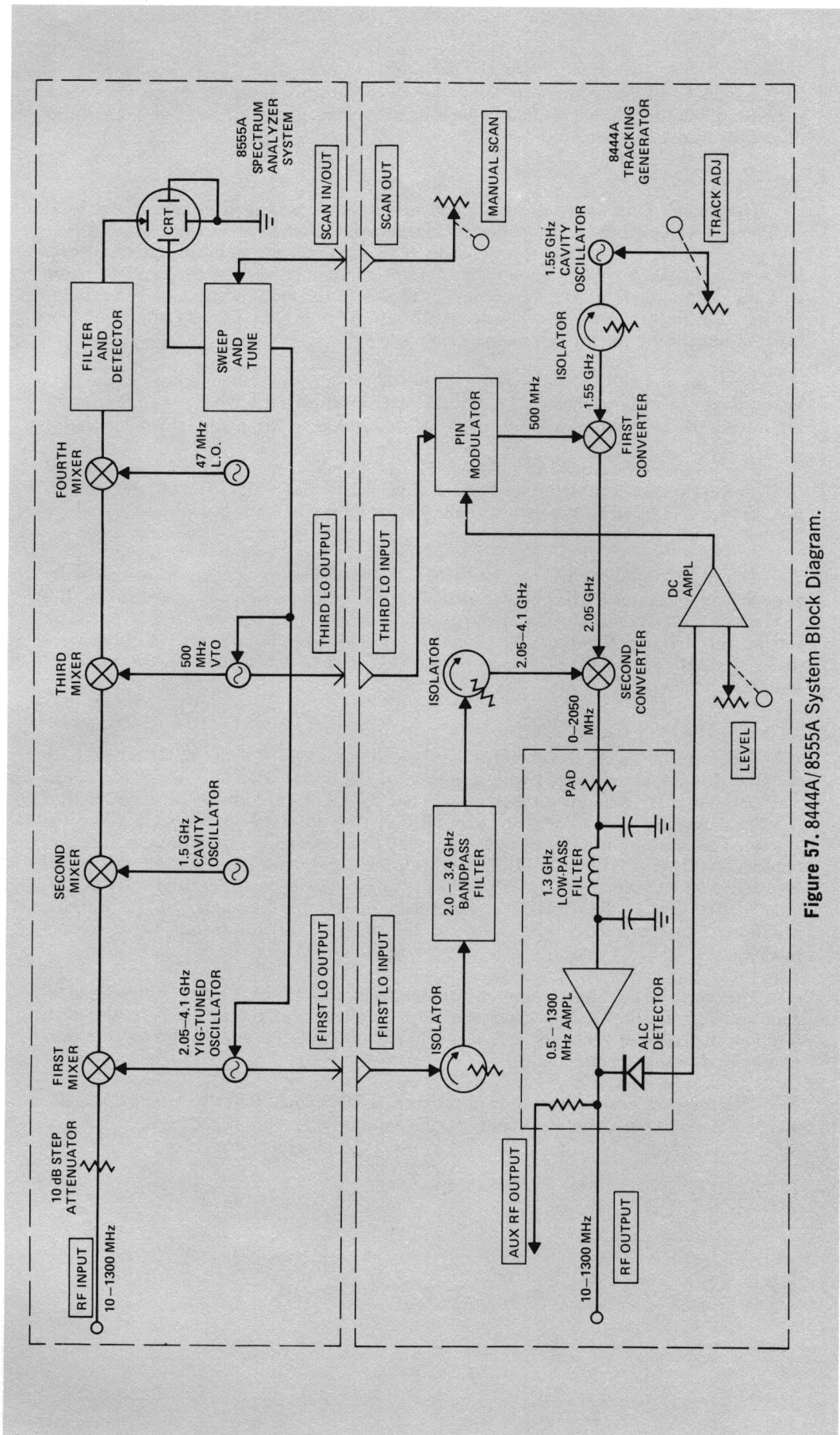

Figure 57. 8444A/8555A System Block Diagram.

8556A

A simplified block diagram is shown for the 8556A in Figure 58. Since the 8556A is both an analyzer tuning section as well as a tracking generator, it is appropriate to discuss its analyzer operation briefly.

THE ANALYZER

The 8556A is basically a double conversion receiver with a swept second local oscillator. The input signal passes through an amplifier-attenuator network which serves two purposes. First, it adjusts the signal level to the input mixer to an optimum level for a wide dynamic range. Second, the gain is adjusted to the proper level to agree with the calibration selected. For example, the gain in the input amplifier will be different for dBm in 600 ohms than it will for dBm in 50 ohms. This gain compensation is made automatically for the calibration mode in use.

After passing through a low-pass filter, the conditioned signal goes to the first mixer. Here the signal is mixed with a 50.15 MHz fixed crystal oscillator, and the resulting mixing products are passed by the 50 MHz bandpass filter in the IF section.

The lower sideband (50.15 - 49.85 MHz) is mixed with a 47 MHz voltage-tuned oscillator to produce a 3 MHz signal which is passed by the 3 MHz IF. The IF signal is then detected and fed to the vertical deflection amplifier to form the vertical signal for the CRT.

The 8556A provides RF markers every 20 kHz. These markers are generated by the tracking generator 3 MHz crystal oscillator. The 3 MHz frequency is divided by 150 to produce a 20 kHz signal. A harmonic generator produces a frequency "comb" based on this 20 kHz frequency output. This comb is injected into the first mixer to produce a series of signals spaced 20 kHz apart on the CRT display when the "20 kHz markers" switch is depressed.

THE TRACKING GENERATOR

A portion of the 47 MHz swept local oscillator signal (in the 8552) is fed back to the 8556 section and mixed with a portion of the 50.15 MHz local oscillator signal. The 3.0 - 3.3 MHz difference signal is selected by a low-pass filter and mixed with a 3 MHz signal which is adjusted by the TRACK ADJ to match the 3 MHz IF of the system. The resulting 0 - 300 kHz mixing product passes through the low-pass filter and appears at TRACKING GEN OUT on the front panel. The frequency of this signal precisely tracks the tuning frequency of the spectrum analyzer. A fine frequency adjustment (± 150 Hz) on the 3 MHz crystal oscillator sets the frequency of the tracking generator signal exactly in the center of the analyzer IF bandwidth for maximum tracking.

The tracking generator output is variable from 100 mV to 3 volts. A flat variable-gain amplifier in the tracking generator output controls the output level. In the CAL position, the tracking generator output is 100 mV into an open circuit; this level is used to amplitude calibrate the analyzer.

The tracking generator output impedance is 600 ohms. Refer to pages 28-31 for more on measurements with this source impedance.

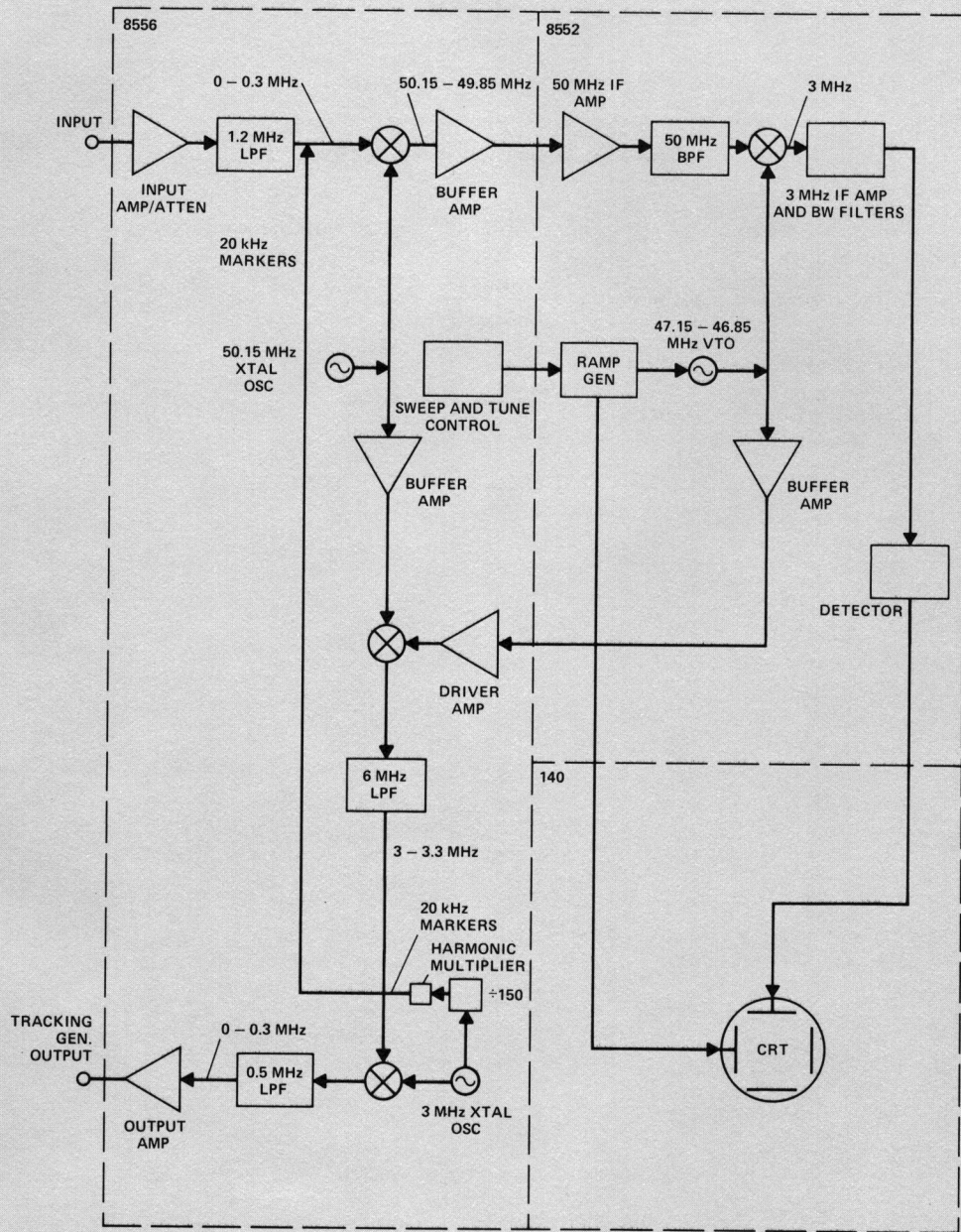

Figure 58. 8556A Block Diagram.

APPENDIX B
DEVICE CHARACTERIZATION
Transmission/Reflection

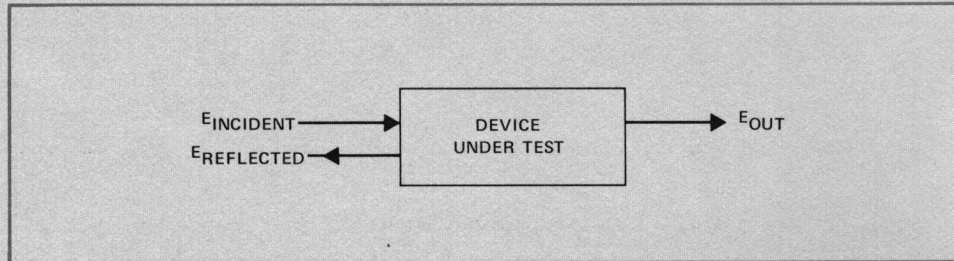

Figure 59. Transmission/Reflection.

Using this diagram, we can define three frequency variable characteristics of the device under test:

1. Insertion Loss or Gain = $20 \log \frac{E_{\text{OUT}}}{E_{\text{INCIDENT}}}$
2. Reflection Coefficient $\rho = \frac{E_{\text{REFLECTED}}}{E_{\text{INCIDENT}}}$
3. Return Loss = $-20 \log \rho$